



i3TOUCH E-ONE

i3TOUCH E-ONE

Experience Ultimate Value.

The i3TOUCH E-ONE delivers durability, and an all-in-one integrated experience for an incredible value. With high-precision IR technology and zero air gap, the E-ONE gives you an excellent multi-touch experience.

Powered by
Android 11

55"

65"

75"

86"

i3TOUCH E·ONE

Discover the features



Experience ultimate value.

The i3TOUCH E-ONE delivers durability, and an all-in-one integrated experience for an incredible value. With high-precision IR technology and zero air gap, the E-ONE gives you an excellent multi-touch experience. Running on Android 11 and preloaded with all the interactive essentials you need – whiteboard, annotate, present, browsing and video conferencing – the i3TOUCH E-ONE is a powerful asset for your classroom or office. Using i3RDM (Remote Display Management) you can work with ease and manage the i3TOUCH E-ONE remotely.

Have a hybrid meeting or lesson? Add a camera to your setup: one of your choosing from our integration partners, or an i3CAMERA to achieve a budget-friendly video conferencing solution. Host video conferences or classes with your own software by connecting your laptop to the E-ONE with a USB-C cable. Just one cable for audio, video, power, and touch.



OPERATES ON
ANDROID 11



ONE CABLE
CONNECTION



VIDEO
CONFERENCING



HIGH
PRECISION IR



REMOTE DISPLAY
MANAGEMENT



i3STUDIO

Free software included.

Our interactive displays are powered by i3STUDIO – our **free, pre-installed** software suite which includes: **whiteboard, annotate, wireless presenting, video conferencing.**

i3STUDIO gives you access to your favorite apps and internet browser with just **one touch** on the intuitive interface. With a state-of-the-art OTA (Over-The-Air) platform, you can be sure your device is always up to date with the latest firmware. All of this is included in i3STUDIO with **free updates, forever.**

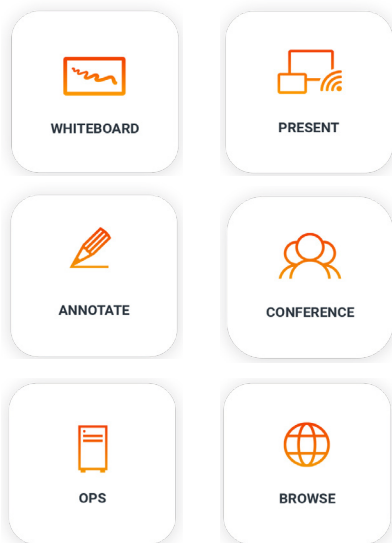

Full stack for great performance

i3STUDIO is built on completely new and future-proof technical architecture with improved management capabilities including: notification and messaging system, integrated support, and OTA updates.



Go-to apps at your fingertips

The apps you rely on daily are available on i3STORE. Using the secure environment you can browse, install, update, and keep track of your apps on i3STUDIO. PowerPoint, Word, Zoom, digital signage, and more.



Free lifelong updates

Forever-free automatic updates. No subscription fees, hassle-free updates, and one seamless updating process - all Over-The-Air. You will always use the latest software version even if you bought your device years ago.

i3TOUCH E-ONE

Compatible products & accessories



i3CAMERA PRO

4K video conferencing camera with wide 120° angle, omnidirectional microphone and low light support.



i3CAIR

The i3CAIR Air Quality Sensor can monitor the air quality of your workspace or classroom and trigger alerts when rooms need to be ventilated.



i3RDM

Manage, maintain, and monitor your fleet of interactive displays from anywhere at any time.

i3TOUCH E-ONE

Product specs



Multi-function button

Define your favorite actions on a hardware button. You can set it to freeze the image, take a screenshot, switch to your preferred video input source and more.



i3STUDIO

Our interactive displays are pre-installed with i3STUDIO. i3STUDIO delivers everything you need to accomplish your best lesson, pitch, presentation or brainstorming session. Leave the room dazzled.



Just one cable

The i3TOUCH E-ONE allows devices with a USB-C connection to be connected to the screen with one cable for image, audio, touch, power (65W) and camera.



Easy Input

Enjoy the freedom of connectivity with the frontal USB-C and HDMI input slots.

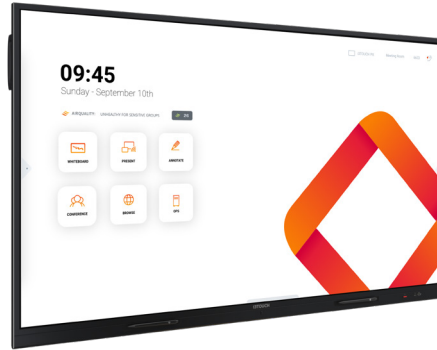

Integrated Speakers

The integrated audio system pumps out loud and full-bodied sound that is capable of filling a whole room.



Multitasking

Supports split-screen mode allowing you to use two apps at the same time on your i3TOUCH E-ONE.



Natural Writing

A natural writing experience is one of our top priorities. Thanks to the zero-air gap technology we were able to achieve a pen-to-paper feeling.



Motion and light sensor

The combination of a motion and light sensor will optimize your viewing experience to all lighting conditions and keep energy consumption balanced.

DISPLAY PROPERTIES

| | 55" | 65" | 75" | 86" |
|----------------|--|------------------|------------------|------------------|
| Model Name | i3TOUCH E-ONE 55 | i3TOUCH E-ONE 65 | i3TOUCH E-ONE 75 | i3TOUCH E-ONE 86 |
| Product series | i3TOUCH E-ONE Series - Interactive Digital Whiteboard Displays | | | |
| Product ID | 10010352 | 10010354 | 10010353 | 10010352 |

DISPLAY SPECIFICATIONS

| | | | | |
|---------------------------|---|-----|-----|-----|
| Display technology | IPS-ADS Liquid Crystal Display (LCD) | | | |
| Backlight technology | Direct-LED backlight | | | |
| Panel size | 55" | 65" | 75" | 86" |
| Display aspect ratio | 16:9 | | | |
| Display native resolution | 3840 x 2160 pixels - 4K Ultra High Definition | | | |
| Display mode | IPS, transmissive | | | |
| Brightness (typical) | 380 cd/m ² | | | |
| Brightness (maximum) | 450 cd/m ² | | | |
| Contrast ratio (typical) | 1200:1 | | | |
| Dynamic contrast ratio | 4000:1 | | | |
| Viewing angle | 178° / 178° | | | |
| Colour depth | 1.07 billion colors (10 bit) | | | |
| Colour gamut | 72% NTSC | | | |
| Response time (typ.) | 8 ms | | | |
| Refresh rate | 60 Hz (@ UHD) | | | |
| Surface | Antiglare, Hard coating 7H | | | |
| Supported orientation | Landscape | | | |
| Lifetime | 50.000 hours | | | |

CONNECTIVITY

| | |
|--------------------------------|---|
| Digital audio-video input | 1x HDMI 2.0 incl CEC + ARC |
| | 1x HDMI 2.0 incl CEC |
| | 1x HDMI 2.0 |
| Digital audio-video output | 1x HDMI 2.0 |
| Digital audio-video-data ports | 1x USB 3.0 Type C, incl PowerDelivery 65W charging, Alternate Mode DP, and USB data |
| | 1x USB 3.0 Type C, incl Alternate Mode DP, and USB data |
| Digital audio output | 1x S/PDIF Optical |
| Analog video input | 1x VGA |
| Analog audio output | 3,5 mm audio jack TRS |
| Integrated OPS slot | OPS-PC slot (JAE TX24 connector) UHD |
| USB Data ports | 3x USB 2.0 Type A |
| | 2x USB 3.0 Type A |
| Control input | COM DE-9 (RS-232 standard) |
| Network connectivity | 2x LAN: RJ-45 connector (1000 Mbit/sec) |
| | Wi-Fi 6 (802.11ax) |

OPERATIONAL SPECIFICATIONS

| | |
|-------------------|--|
| Operating System | Android 11 |
| Architecture | CPU : ARM A55 (4 cores) |
| | Clock speed : 2.3 GHz |
| | Cores : 4 |
| | GPU : Mali G52 MP2 |
| | RAM : 4 GB DDR4 |
| | ROM : 32 GB |
| Interactive touch | Technology: V-SENSE Infrared Touch recognition |
| | Resolution : 32768 x 32768 |
| | Accuracy : 1 mm |
| | Response time: 6ms (single touch), < 30ms (multitouch) |
| | Connection : 2x USB-B 2.0 + 2x USB-C 3.0 |
| | Connection protocol: HID (Human Interface Device) |
| | Touch Points: 40 simultaneous multi-touch points |
| Loudspeakers | 2x 16 Watt |
| Subwoofer | 1x 16 Watt |

ACCESSOIRES

| | |
|----------|---------------------------|
| Included | Quick Start Guide |
| | IR Remote Control Unit |
| | 2x Passive Stylus |
| | Power Cable (EU, US) |
| | USB-C Cable |
| | HDMI 2.0 Cable |
| | USB 2.0 Cable A-B (TOUCH) |
| | Wall Mount |

PHYSICAL PROPERTIES

| | | | | |
|-----------------------|---------------------|----------------------|----------------------|----------------------|
| VESA Mounting Pattern | 400x200 | 600x400 | 800x400 | 800x600 |
| Net Weight | 28.16 kg | 36.15 kg | 48.45 kg | 63.30 kg |
| Packaged Weight | 39.12 kg | 46.25 kg | 61.85 kg | 80.60 kg |
| Product Dimensions | 1268 x 786 x 87 mm | 1491 x 905 x 87 mm | 1712 x 1030 x 87 mm | 1959 x 1169 x 87 mm |
| Packaging Dimensions | 1401 x 220 x 859 mm | 1644 x 197 x 1046 mm | 1853 x 216 x 1129 mm | 2098 x 215 x 1278 mm |

ELECTRICAL PROPERTIES

| | | | | |
|------------------------|--|---------|---------|----------|
| Input Power | 100 ~ 240 Volt – 50/60 Hz | | | |
| Energy Saving Features | Auto-brightness adjustment by Ambient Light Sensor | | | |
| Power Consumption | 75 Watt | 82 Watt | 90 Watt | 148 Watt |

SOFTWARE FEATURES

| | |
|------------------------|---|
| User Interface | i3STUDIO (Fully Customizable Launcher) |
| Whiteboarding Software | i3WHITEBOARD |
| Annotation Software | i3WHITEBOARD |
| Screencasting Software | i3ALLSYNC Wireless Presenting |
| Operating System | Android 11 |
| Update Support | OTA (Over-the-Air) |
| Web Browser | Chromium |
| Support | Apple Airplay & Google Chromecast |
| Conferencing | Zoom, Teams, or browser-based |
| App Store | i3STORE (ability to download and install apps) |
| Remote Support | Ability to offer remote assistance (requires i3RDM license) |

REGULATORY INFORMATION

| | |
|---------------|---------|
| Type Approval | CE, FCC |
|---------------|---------|

ENVIRONMENTAL CONDITIONS

| | |
|----------------------------|------------------------------|
| Operating Temperature | 0° C to 40° C |
| Operating Humidity | 10% to 90% RH non-condensing |
| Operating Maximum Altitude | 5,000 meters |
| Storage Temperature | -20° C to 40° C |
| Storage Humidity | 10% to 90% RH non-condensing |

WARRANTY

| | |
|-------------------|--|
| Standard Warranty | 3 years |
| Extended Warranty | for education entities: 5 years (via registration) for corporate entities: 5 years (available for purchase) |

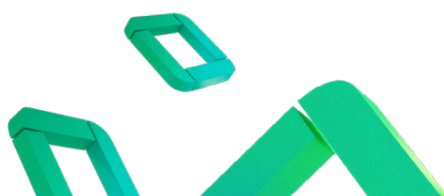

i3TOUCH E·ONE

Technical Drawings

E-ONE 55"

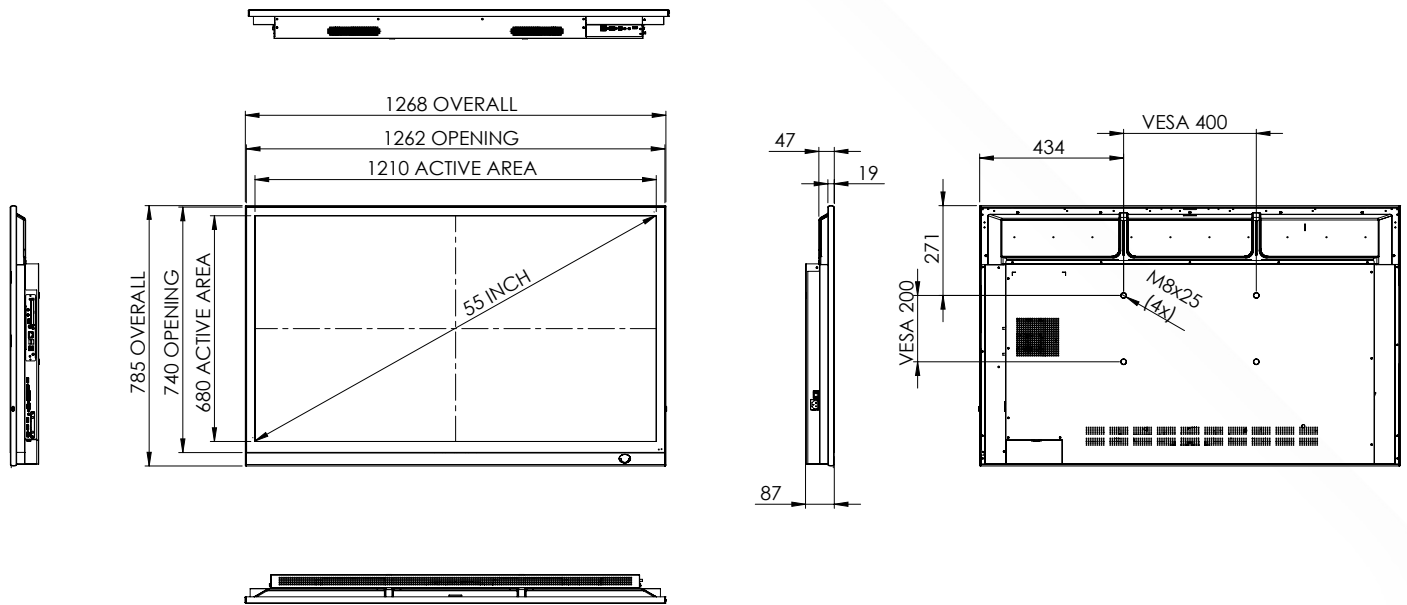

E-ONE 65"

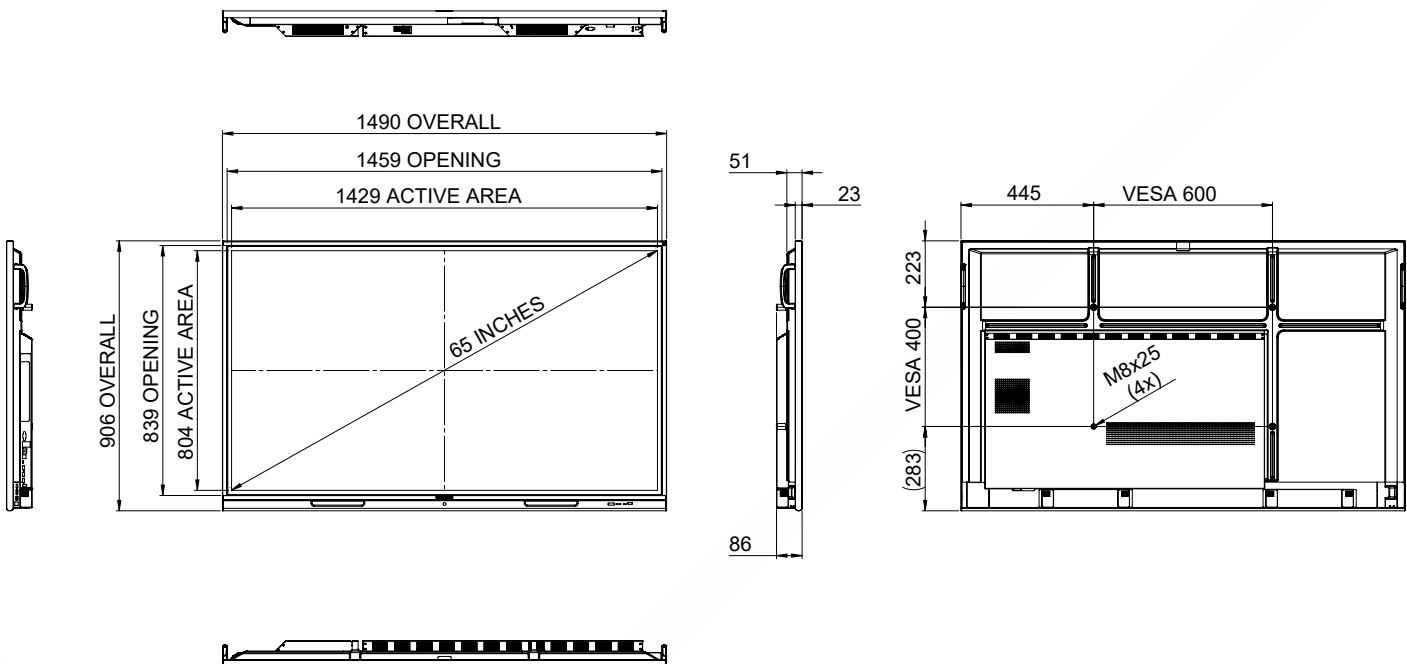

E-ONE 75"

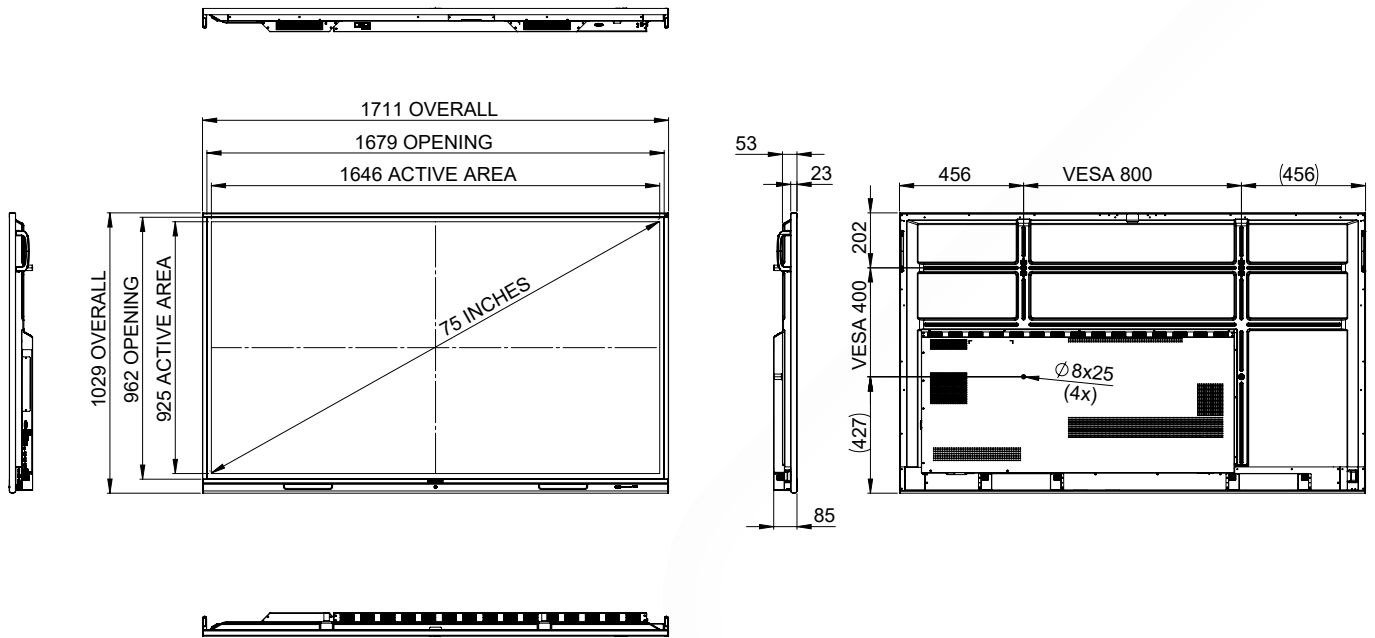

E-ONE 86"

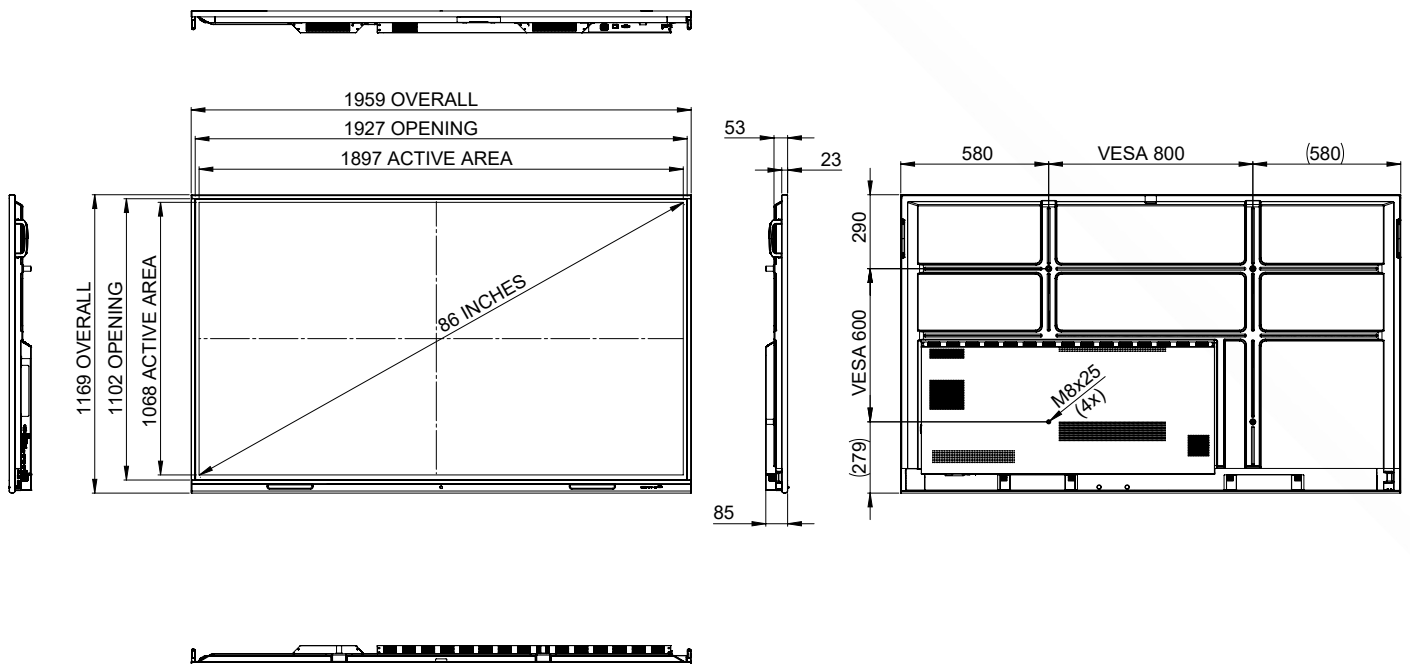

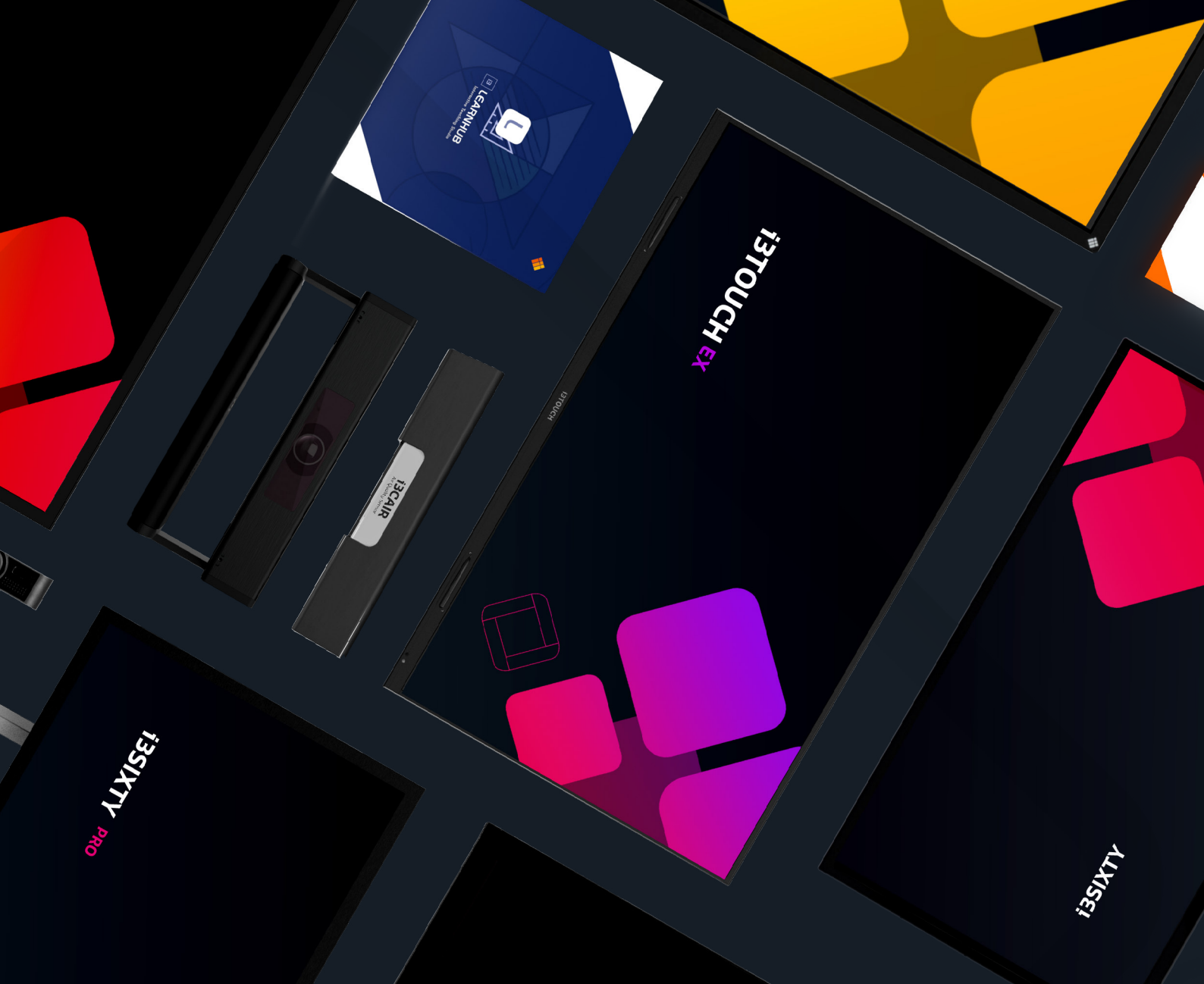

Like to know more?

i3-TECHNOLOGIES HQ
Kleine Schaluinweg 7
3290 Diest
Belgium

+32 56 31 34 15
info@i3-technologies.com



i3-TECHNOLOGIES