

TouchLink Pro Touchpanels

TLP Pro 1220, TLP Pro 1520, and TLP Pro 1720 Series

TouchLink Pro Touchpanel Control Systems

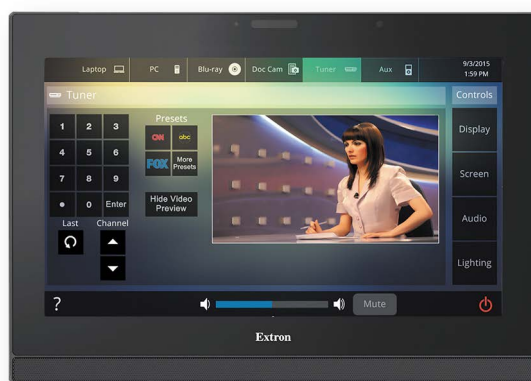

Extron Electronics
INTERFACING, SWITCHING AND CONTROL

Safety Instructions

Safety Instructions • English

WARNING: This symbol, , when used on the product, is intended to alert the user of the presence of uninsulated dangerous voltage within the product's enclosure that may present a risk of electric shock.

ATTENTION: This symbol, , when used on the product, is intended to alert the user of important operating and maintenance (servicing) instructions in the literature provided with the equipment.

For information on safety guidelines, regulatory compliances, EMI/EMF compatibility, accessibility, and related topics, see the Extron Safety and Regulatory Compliance Guide, part number 68-290-01, on the Extron website, www.extron.com.

Sicherheitsanweisungen • Deutsch

WARNUNG: Dieses Symbol , auf dem Produkt soll den Benutzer darauf aufmerksam machen, dass im Inneren des Gehäuses dieses Produktes gefährliche Spannungen herrschen, die nicht isoliert sind und die einen elektrischen Schlag verursachen können.

VORSICHT: Dieses Symbol , auf dem Produkt soll dem Benutzer in der im Lieferumfang enthaltenen Dokumentation besonders wichtige Hinweise zur Bedienung und Wartung (Instandhaltung) geben.

Weitere Informationen über die Sicherheitsrichtlinien, Produkthandhabung, EMI/EMF-Kompatibilität, Zugänglichkeit und verwandte Themen finden Sie in den Extron-Richtlinien für Sicherheit und Handhabung (Artikelnummer 68-290-01) auf der Extron-Website, www.extron.com.

Instrucciones de seguridad • Español

ADVERTENCIA: Este símbolo, , cuando se utiliza en el producto, avisa al usuario de la presencia de voltaje peligroso sin aislar dentro del producto, lo que puede representar un riesgo de descarga eléctrica.

ATENCIÓN: Este símbolo, , cuando se utiliza en el producto, avisa al usuario de la presencia de importantes instrucciones de uso y mantenimiento recogidas en la documentación proporcionada con el equipo.

Para obtener información sobre directrices de seguridad, cumplimiento de normativas, compatibilidad electromagnética, accesibilidad y temas relacionados, consulte la Guía de cumplimiento de normativas y seguridad de Extron, referencia 68-290-01, en el sitio Web de Extron, www.extron.com.

Instructions de sécurité • Français

AVERTISSEMENT : Ce pictogramme, , lorsqu'il est utilisé sur le produit, signale à l'utilisateur la présence à l'intérieur du boîtier du produit d'une tension électrique dangereuse susceptible de provoquer un choc électrique.

ATTENTION : Ce pictogramme, , lorsqu'il est utilisé sur le produit, signale à l'utilisateur des instructions d'utilisation ou de maintenance importantes qui se trouvent dans la documentation fournie avec le matériel.

Pour en savoir plus sur les règles de sécurité, la conformité à la réglementation, la compatibilité EMI/EMF, l'accessibilité, et autres sujets connexes, lisez les informations de sécurité et de conformité Extron, réf. 68-290-01, sur le site Extron, www.extron.com.

Istruzioni di sicurezza • Italiano

AVVERTENZA: Il simbolo, , se usato sul prodotto, serve ad avvertire l'utente della presenza di tensione non isolata pericolosa all'interno del contenitore del prodotto che può costituire un rischio di scosse elettriche.

ATTENZIONE: Il simbolo, , se usato sul prodotto, serve ad avvertire l'utente della presenza di importanti istruzioni di funzionamento e manutenzione nella documentazione fornita con l'apparecchio.

Per informazioni su parametri di sicurezza, conformità alle normative, compatibilità EMI/EMF, accessibilità e argomenti simili, fare riferimento alla Guida alla conformità normativa e di sicurezza di Extron, cod. articolo 68-290-01, sul sito web di Extron, www.extron.com.

Instrukcje bezpieczeństwa • Polska

OSTRZEŻENIE: Ten symbol, , gdy używany na produkt, ma na celu poinformować użytkownika o obecności izolowanego i niebezpiecznego napięcia wewnątrz obudowy produktu, który może stanowić zagrożenie porażenia prądem elektrycznym.

UWAGI: Ten symbol, , gdy używany na produkt, jest przeznaczony do ostrzegania użytkownika ważne operacyjne oraz instrukcje konserwacji (obsługi) w literaturze, wyposażone w sprzęt.

Informacji na temat wytycznych w sprawie bezpieczeństwa, regulacji wzajemnej zgodności, zgodność EMI/EMF, dostępności i Tematy pokrewne, zobacz Extron bezpieczeństwa i regulacyjnego zgodności przewodnik, część numer 68-290-01, na stronie internetowej Extron, www.extron.com.

Инструкция по технике безопасности • Русский

ПРЕДУПРЕЖДЕНИЕ: Данный символ, , если указан на продукте, предупреждает пользователя о наличии неизолированного опасного напряжения внутри корпуса продукта, которое может привести к поражению электрическим током.

ВНИМАНИЕ: Данный символ, , если указан на продукте, предупреждает пользователя о наличии важных инструкций по эксплуатации и обслуживанию в руководстве, прилагаемом к данному оборудованию.

Для получения информации о правилах техники безопасности, соблюдении нормативных требований, электромагнитной совместимости (ЭМП/ЭДС), возможности доступа и других вопросах см. руководство по безопасности и соблюдению нормативных требований Extron на сайте Extron: www.extron.com, номер по каталогу - 68-290-01.

安全说明 • 简体中文

警告: 产品上的这个标志意在警告用户该产品机壳内有暴露的危险电压, 有触电危险。

注意: 产品上的这个标志意在提示用户设备随附的用户手册中有重要的操作和维护(维修)说明。

关于我们产品的安全指南、遵循的规范、EMI/EMF 的兼容性、无障碍使用的特性等相关内容, 敬请访问 Extron 网站 www.extron.com, 参见 Extron 安全规范指南, 产品编号 68-290-01。

安全記事 • 繁體中文

警告: ⚠ 若產品上使用此符號, 是為了提醒使用者, 產品機殼內存在著可能導致觸電之風險的未絕緣危險電壓。

注意: ⚠ 若產品上使用此符號, 是為了提醒使用者, 設備隨附的用戶手冊中有重要的操作和維護(維修)說明。

有關安全性指導方針、法規遵守、EMI/EMF 相容性、存取範圍和相關主題的詳細資訊, 請瀏覽 Extron 網站: www.extron.com, 然後參閱《Extron 安全性與法規遵守手冊》, 準則編號 68-290-01。

安全上のご注意 • 日本語

警告: この記号 ⚠ が製品上に表示されている場合は、筐体内に絶縁されていない高電圧が流れ、感電の危険があることを示しています。

注意: この記号 ⚠ が製品上に表示されている場合は、本機の取扱説明書に記載されている重要な操作と保守(整備)の指示についてユーザーの注意を喚起するものです。

安全上のご注意、法令遵守、EMI/EMF適合性、その他の関連項目については、エクストロンのウェブサイト www.extron.com より「Extron Safety and Regulatory Compliance Guide」(P/N 68-290-01)をご覧ください。

안전 지침 • 한국어

경고: 이 기호 ⚠, 가 제품에 사용될 경우, 제품의 인클로저 내에 있는 접지되지 않은 위험한 전류로 인해 사용자가 감전될 위험이 있음을 경고합니다.

주의: 이 기호 ⚠, 가 제품에 사용될 경우, 장비와 함께 제공된 책자에 나와 있는 주요 운영 및 유지보수(정비) 지침을 경고합니다.

안전 가이드라인, 규제 준수, EMI/EMF 호환성, 접근성, 그리고 관련 항목에 대한 자세한 내용은 Extron 웹 사이트(www.extron.com)의 Extron 안전 및 규제 준수 안내서, 68-290-01 조항을 참조하십시오.

Copyright

© 2016 Extron Electronics. All rights reserved.

Trademarks

All trademarks mentioned in this guide are the properties of their respective owners.

The following registered trademarks®, registered service marks^(SM), and trademarks^(TM) are the property of RGB Systems, Inc. or Extron Electronics (see the current list of trademarks on the [Terms of Use](#) page at www.extron.com):

Registered Trademarks ®

AVTrac, Cable Cubby, ControlScript, CrossPoint, DTP, eBUS, EDID Manager, EDID Minder, Extron, Flat Field, FlexOS, GlobalViewer, Global Configurator, Global Scriptor, Hideaway, Inline, IP Intercom, IP Link, Key Minder, LinkLicense, LockIt, MediaLink, MediaPort, NetPA, PlenumVault, PoleVault, PowerCage, PURE3, Quantum, SoundField, SpeedMount, SpeedSwitch, System *INTEGRATOR*, TeamWork, TouchLink, V-Lock, VersaTools, VN-Matrix, VoiceLift, WallVault, WindoWall, XTP, and XTP Systems

Registered Service Mark^(SM) : S3 Service Support Solutions

Trademarks^(TM)

AAP, AFL (Accu-Rate Frame Lock), ADSP (Advanced Digital Sync Processing), Auto-Image, CableCover, CDRS (Class D Ripple Suppression), DDSP (Digital Display Sync Processing), DMI (Dynamic Motion Interpolation), Driver Configurator, DSP Configurator, DSVP (Digital Sync Validation Processing), eLink, Entwine, EQIP, FastBite, FOX, FOXBOX, IP Intercom HelpDesk, MAAp, MicroDigital, Opti-Torque, ProDSP, QS-FPC (QuickSwitch Front Panel Controller), Room Agent, Scope-Trigger, ShareLink, SIS, Simple Instruction Set, Skew-Free, SpeedNav, Triple-Action Switching, True4K, VectorTM 4K, WebShare, XTRA, ZipCaddy, and ZipClip

FCC Class A Notice

This equipment has been tested and found to comply with the limits for a Class A digital device, pursuant to part 15 of the FCC rules. The Class A limits provide reasonable protection against harmful interference when the equipment is operated in a commercial environment. This equipment generates, uses, and can radiate radio frequency energy and, if not installed and used in accordance with the instruction manual, may cause harmful interference to radio communications. Operation of this equipment in a residential area is likely to cause interference. This interference must be corrected at the expense of the user.

NOTES:

- This unit was tested with shielded I/O cables on the peripheral devices. Shielded cables must be used to ensure compliance with FCC emissions limits.
- For more information on safety guidelines, regulatory compliances, EMI/EMF compatibility, accessibility, and related topics, see the [Extron Safety and Regulatory Compliance Guide](#) on the Extron website.

Battery Notice

This product contains a battery. **Do not open the unit to replace the battery.** If the battery needs replacing, return the entire unit to Extron (for the correct address, see the [Extron Warranty](#) section on the last page of this guide).

CAUTION: Risk of explosion if battery is replaced by an incorrect type. Dispose of used batteries according to the instructions.

ATTENTION : Risque d'explosion. Ne pas remplacer la pile par le mauvais type de pile. Débarrassez-vous des piles utilisées selon le mode d'emploi.

Conventions Used in this Guide

Notifications

In this user guide, the following are used:

WARNING: Potential risk of severe injury or death.

AVERTISSEMENT : Risque potentiel de blessure grave ou de mort.

CAUTION: Risk of minor personal injury.

ATTENTION : Risque de blessure mineure.

ATTENTION:

- Risk of property damage.
- Risque de dommages matériels.

NOTE: A note draws attention to important information.

Software Commands

Commands are written in the fonts shown here:

```
^ARMerge Scene,,Op1 scene 1,1 ^B51 ^W^C
[Ø1] RØØØ4 ØØ3ØØ ØØ4ØØ ØØ8ØØ ØØ6ØØ [Ø2] 35 [17] [Ø3]
[Esc][X1]*[X17]*[X20]*[X23]*[X21]CE ←
```

NOTE: For commands and examples of computer or device responses mentioned in this guide, the character “Ø” is used for the number zero and “O” represents the capital letter “o”.

Computer responses and directory paths that do not have variables are written in the font shown here:

```
Reply from 2Ø8.132.18Ø.48: bytes=32 times=2ms TTL=32
C:\Program Files\Extron
```

Variables are written in slanted form as shown here:

```
ping xxx.xxx.xxx.xxx -t
SOH R Data STX Command ETB ETX
```

Selectable items, such as menu names, menu options, buttons, tabs, and field names are written in the font shown here:

```
From the File menu, select New.
Click the OK button.
```

Specifications Availability

Product specifications are available on the Extron website, www.extron.com.

Extron Glossary of Terms

A glossary of terms is available at www.extron.com/technology/glossary.aspx.



Contents

Introduction..... 1

| | |
|--|---|
| About the TLP Pro 1220, 1520, and 1720 Series | 1 |
| Features..... | 2 |
| Application Diagram | 3 |
| Requirements..... | 3 |
| Software | 3 |
| Hardware | 3 |

Installation Overview 4

Panel Features 6

| | |
|-------------------------------------|----|
| TLP Pro 1220, 1520, and 1720 Series | |
| Front Panel Features | 6 |
| TLP Pro 1220, 1520, and 1720 Series | |
| Rear Panel Features..... | 8 |
| Routing Cables (TG Models)..... | 13 |

Setup Menu..... 14

| | |
|----------------------|----|
| Setup Menu | 14 |
| Status Screen | 15 |
| Network Screen | 15 |
| Display Screen | 17 |
| Audio Screen | 18 |
| Input Screen | 18 |
| Advanced Screen..... | 20 |

Configuration Software..... 21

| | |
|---|----|
| Configuration Software..... | 21 |
| Installing GUI Designer, Global Configurator, | |
| and Toolbelt | 22 |
| Using the Software..... | 23 |
| TLP Pro 1220, 1520, and 1720 Series | |
| Web Pages | 23 |
| Updating the Firmware | 24 |
| Downloading Firmware..... | 24 |
| Updating Firmware Using the Touchpanel | |
| Web Page..... | 24 |
| Updating Firmware Using Toolbelt | 24 |

Mounting..... 25

| | |
|--------------------------------------|----|
| Mounting the TLP Pro 1220MG, 1520MG, | |
| and 1720MG | 25 |
| Rack Mounting..... | 25 |
| Wall Mounting | 26 |
| Mounting the TLP Pro 1220TG, 1520TG, | |
| and 1720TG | 29 |
| Desktop Mounting | 29 |
| VESA Mounting..... | 30 |

Reference Material..... 31

| | |
|---|----|
| Network Port Requirements and Licensed | |
| Third-Party Software Used by the Touchpanels | 31 |
| Reset Modes..... | 31 |
| Use Factory Firmware | 31 |
| Reset All IP Settings..... | 32 |
| Reset to Factory Defaults | 32 |

Introduction

This guide describes the function, installation, and operation of the following Extron Touchlink Pro Touchpanels:

- TLP Pro 1220MG
- TLP Pro 1520MG
- TLP Pro 1720MG
- TLP Pro 1220TG
- TLP Pro 1520TG
- TLP Pro 1720TG

Unless otherwise stated, the terms “touchpanel” or “TLP Pro” refer to any of the six models.

The touchpanels are ideal for any AV applications requiring large touchpanels with flexible mounting options and fully customizable interfaces.

This section provides an overview of these products:

- [About the TLP Pro 1220, 1520, and 1720 Series](#)
- [Features](#)
- [Application Diagram](#)
- [Requirements](#)

About the TLP Pro 1220, 1520, and 1720 Series

The TLP Pro 1220 Series touchpanels have 12.1 inch screens with a resolution of 1280x800.

The TLP Pro 1520 Series touchpanels have 15.6 inch screens with a resolution of 1366x768.

The TLP Pro 1720 Series touchpanels have 17.3 inch screens with a resolution of 1920x1080.

The MG models (TLP Pro 1220MG, TLP Pro 1520MG, and TLP Pro 1720MG) are wall-mountable. The TG models (TLP Pro 1220TG, TLP Pro 1520TG, and TLP Pro 1720TG) have a weighted base that can be tilted, which allows them to stand on any suitable table or desktop. A range of mounting options are available for all the models (see [Mounting](#) on page 24).

The screen layout is designed with the Extron GUI Designer software. The functions are assigned to the screen objects with the Extron Global Configurator Plus and Professional software. This provides versatility and adaptability to the configuration and control of an AV system.

A motion sensor, a light sensor, and a speaker provide sleep mode, auto dimming, and audible feedback.

Features

- **Capacitive touchscreen with 16 million colors** —
 - 12.1 inch screen with 1280x800 resolution (TLP Pro 1220 series)
 - 15.6 inch screen with 1366x768 resolution (TLP Pro 1520 series)
 - 17.3 inch screen with 1920x1080 resolution (TLP Pro 1720 series)
- **Faster processing and more memory** — Allows for quicker configuration uploads and more storage for GUI pages.
- **Full motion video preview and monitoring** — With HDMI and XTP inputs
- **Compatible with the full range of Extron IPL Pro and IPCP Pro control processors** — Allows easy integration into existing systems
- **Power over Ethernet** — Touchpanel receives power and communication over a single Ethernet cable, eliminating the need for a local power supply.
- **Built-in speakers provide stereo audio** — For video preview and audible feedback from button presses.
- **3.5 mm headphone jack** — Provides local audio out from the touchpanel.
- **Light sensor** — Adjusts screen brightness as the ambient room lighting changes.
- **Configurable red and green status lights** — Indicate the availability or call status of a room.
- **System connection status indicator** — The communication LED provides visual feedback if the touchpanel is not communicating with a control processor.
- **Two high speed USB 2.0 ports** — For future expansion
- **Automatic clock synchronization** — Allows touchpanel to display the accurate time and date.
- **Energy-saving features** —
 - Adjustable sleep timer puts touchpanel into sleep mode
 - Motion detector wakes touchpanel
- **Mounting options for tilt models (TG models):**
 - Sit on a tabletop — weighted base allows up to 45° of tilt.
 - Threaded holes in baseplate allow for secure mounting to a table.
 - Kensington lock support allows the touchpanels to be locked to a table or other flat surface.
 - Supports the optional SMA-1 Swivel Mount Adapter.
 - VESA FDMI Type D 100 mm mounting pattern standard can be used for VESA mounting.
- **Mounting options for wall-mount models (MG models):**
 - Mount on a wall, lectern, or any flat surface.
 - The optional back box, BB 700M can be used where local codes require a rear metal enclosure.
- **Fully customizable using Extron control system software** — GUI Designer combined with Global Configurator Plus and Professional

Supports the Extron Control App.

Application Diagram

The application diagram below shows the TLP Pro 1220MG. The other touchpanels described in this user guide can be used in similar configurations.

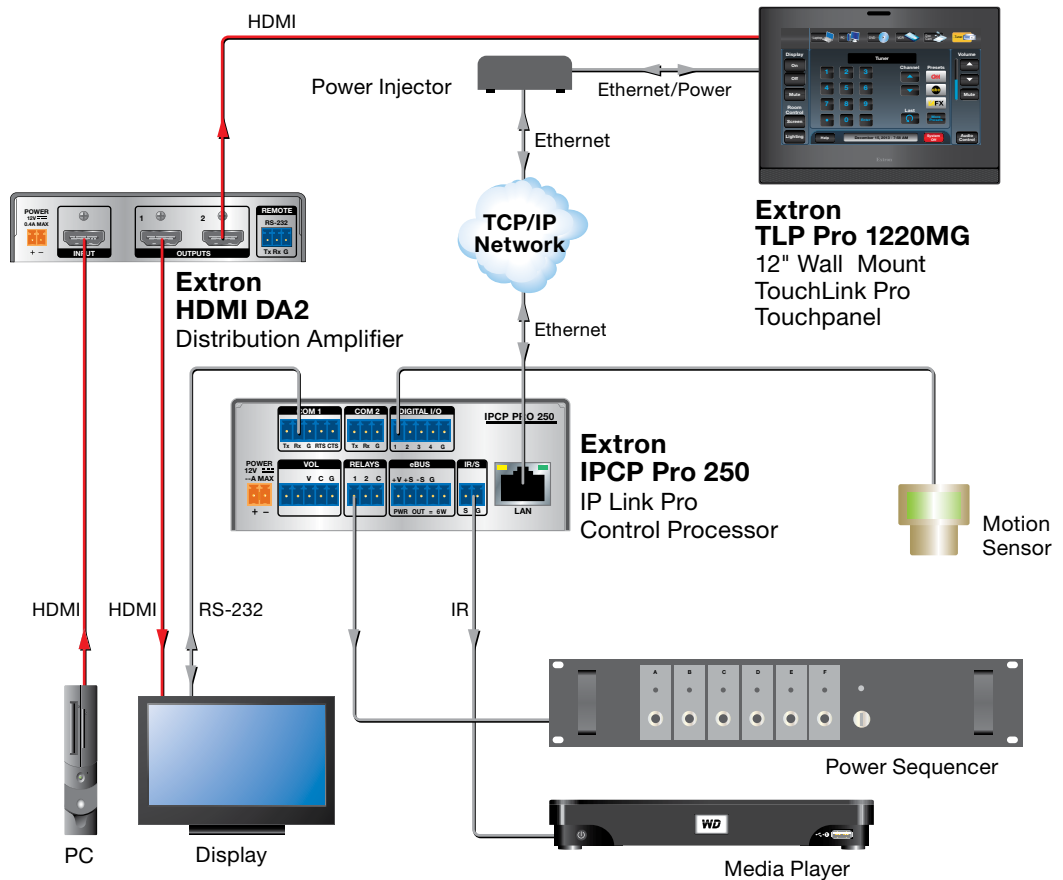

Figure 1. Application Diagram

Requirements

Software

For a complete list of the requirements for running GUI Designer, Global Configurator Plus and Professional, and Toolbelt see the Extron web page for that software.

NOTE: These touchpanels are not compatible with Global Configurator 3 or GUI Configurator.

Hardware

An Extron IP Link Pro control interface must also be connected to the same network domain as the TouchLink panel. See www.extron.com for a list of suitable controllers.

NOTE: These touchpanels are not compatible with Extron IP Link (non-Pro) controllers.

Installation Overview

This section contains an overview of the installation process. Follow the links for a more detailed explanation of each step.

1. Before starting, download and install the latest versions of the following software:
 - GUI Designer** — For designing layouts for Extron TouchLink Pro touchpanels and third party touch interfaces.
 - Global Configurator Plus and Professional** — For setting up and configuring the control processor and touchpanel.
 - Toolbelt** — Provides device discovery, device information, firmware updates, and configuration of network settings, system utilities, and user management for TouchLink Pro devices.

See [Configuration Software](#) on page 20.

2. Obtain the following network information from your network administrator:
 - Dynamic Host Configuration Protocol (DHCP) status (on or off). If DHCP is off, you will also require:
 - IP address
 - Subnet mask
 - Gateway
 - User name — This can be either **admin** or **user**.
 - Password — By default, this is **extron** (for either admin or user).
 - MAC address — Make a note of the touchpanel MAC address, which can be found on the rear panel label (you need to remove the back cover for TG models).
3. Mount and cable the units:

ATTENTION:

- Do not power on the touchpanels or control processors until you have read the Attention notice on [page 11](#) (12 VDC power supply) or on [page 10](#) (power injector).
- Ne branchez pas les écrans tactiles ou les contrôleurs avant d'avoir lu les mises en garde [page 11](#) (source d'alimentation 12 VCC) ou [page 10](#) (injecteur PoE).

- Mount the units. There are several mounting options for TouchLink Pro touchpanels (see [Mounting](#) on page 25).

NOTE: If you use the setup menu to configure the wall-mount models, do not mount the unit before configuring them as you need access to the rear panel **Menu** button.

- Connect cables to the touchpanels. See [TLP Pro 1220, 1520, and 1720 Series Rear Panel Features](#) (page 8).
- Connect the power cords and power on all devices (see [XTP/PoE/LAN input](#) on page 9 or [12V power input](#) on page 11).

4. Set up the touchpanels for network communication:
 - Connect the PC that you are using for setup, the control processor, and the touchpanel to the same Ethernet subnetwork.
 - Use the **Setup Menu** (see page 13) or Toolbelt to set the DHCP status and, if necessary, the IP address, subnet mask, gateway, and related settings for the touchpanel.
5. Configure the Touchpanels — the *GUI Designer Help File*, the *Global Configurator Help File*, and the *Toolbelt Help File* provide step-by-step instructions and detailed information. The *Global Configurator Help File* also includes an introduction to that software and sections on how to start a project and configuration.

Panel Features

This section describes:

- [TLP Pro 1220, 1520, and 1720 Series Front Panel Features](#)
- [TLP Pro 1220, 1520, and 1720 Series Rear Panel Features](#)

TLP Pro 1220, 1520, and 1720 Series Front Panel Features

Figure 2 shows the TLP Pro 1720MG and TLP Pro 1720TG front panels. The features of TLP Pro 1220MG and 1520MG models are very similar to the TLP Pro 1720MG and the features of TLP Pro 1220TG and 1520TG models are very similar to the TLP Pro 1720TG.

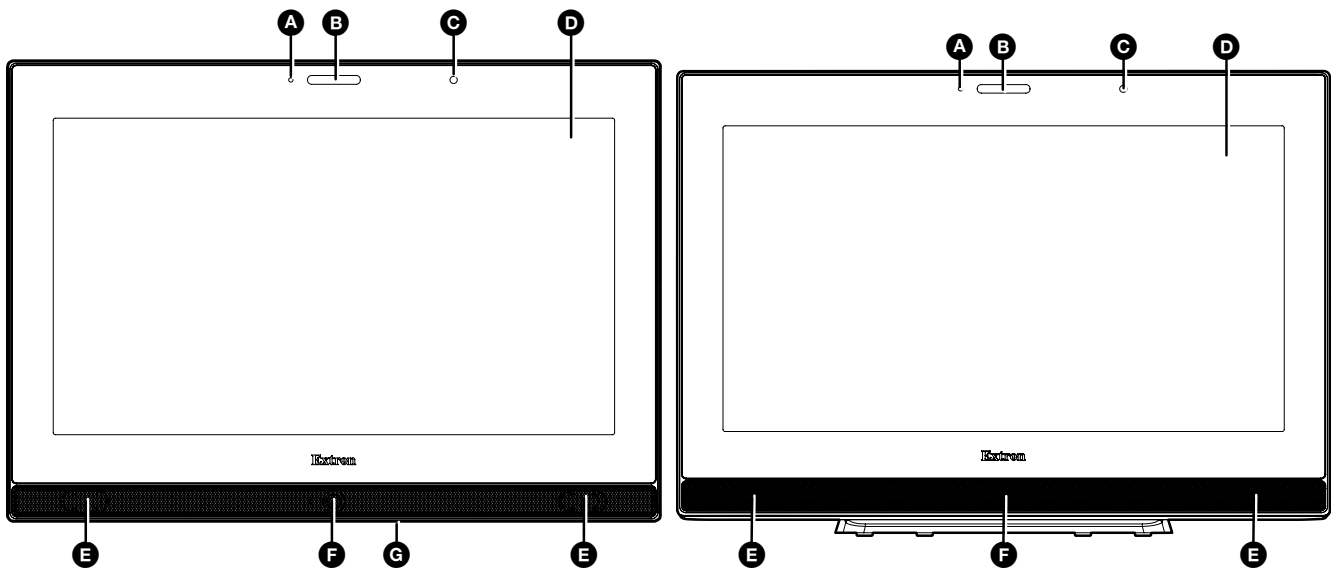

Figure 2. TLP Pro 1720MG (Left) and TLP Pro 1720TG (Right) Front Panels

- A** Communication LED
- B** Status light
- C** Ambient light sensor
- D** Capacitive touch screen
- E** Speakers (2)
- F** Motion sensor
- G** Menu button (MG models only)

- A Communication LED** (see figure 2 on the previous page) — shows the configuration and connection status of the touchpanel:
- Unlit during normal operation (the touchpanel is configured and connected to an IP Link Pro control processor).
 - Blinks red if the touchpanel has been configured but is not connected to an IP Link Pro control processor.
 - Permanently lit if the touchpanel has not been configured.
- The indicator can be toggled between enabled and disabled, using the **Setup Menu** (see page 13).
- B Status light** — one LED light bar, above the screen, which can be programmed to provide system feedback.
- Light red or green
 - Blink or light continuously
- For information about programming this light, see the *Global Configurator Help File*.
- C Ambient light sensor** — monitors ambient light level and adjusts screen brightness, based on the settings configured using the **Setup Menu** (see page 13).
- D Capacitive touch screen** — with a touch overlay. The touchpanel has a resolution of 1280x800 (TLP Pro 1220 series), 1366x768 (TLP Pro 1520 series), or 1920x1080 (TLP Pro 1720 series).
- E Speakers** — two speakers located below the screen, one on each side of the panel, provide stereo audio for video preview and audible feedback from button presses.
- F Motion sensor** — detects motion between three to five feet from the touchpanel, and at least 15° from the center axis.
- When no motion has been detected for a user-defined period of time, the touchpanel enters sleep mode.
 - When motion is detected by the sensor, the screen display is restored and active.
- G Menu Button** (MG models only) — activates the setup menu and calibration screen (see **Setup Menu** on page 13). It is accessed from under the touchpanel.

TLP Pro 1220, 1520, and 1720 Series Rear Panel Features

Figure 3 shows the TLP Pro 1720MG and TLP Pro 1720TG rear panels. The TLP Pro 1720TG is shown with the rear cover removed. The features of TLP Pro 1220MG and 1520MG models are very similar to the TLP Pro 1720MG and the features of TLP Pro 1220TG and 1520TG models are very similar to the TLP Pro 1720TG.

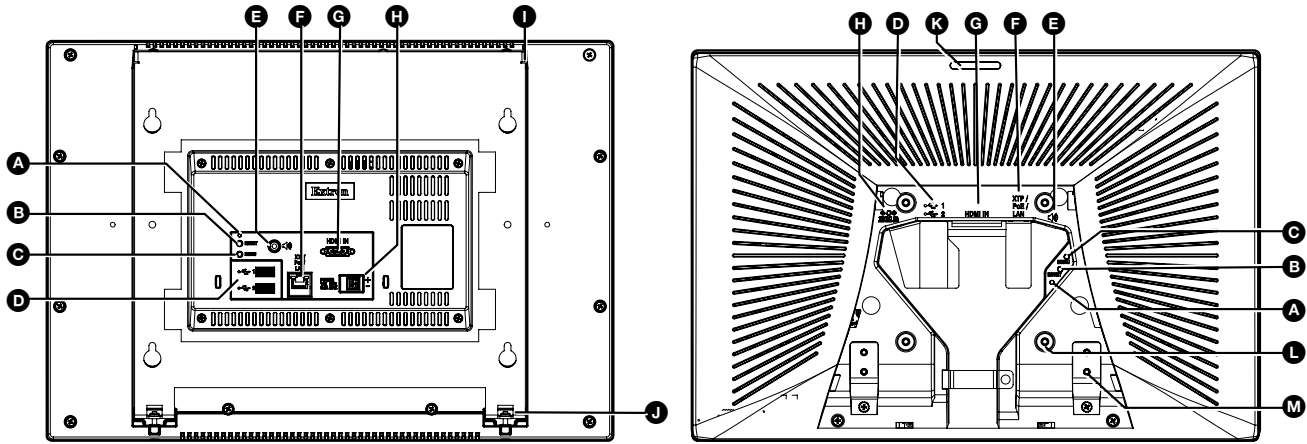

Figure 3. TLP Pro 1720MG (Left) and TLP Pro 1720TG (Right) Rear Panels

- | | |
|-----------------------------------|--|
| A Reset LED | H 12V power input (see page 10) |
| B Reset button | I Mounting notches (MG models only) (see page 11) |
| C Menu button | J Mounting screws (MG models only) (see page 11) |
| D USB connectors (2) | K Rear status light (TG models only) (see page 12) |
| E Audio output | L VESA mounting holes (TG models only) (see page 12) |
| F XTP/PoE/LAN input | M Base attachment hinges (TG models only) (see page 12) |
| G HDMI input (see page 10) | |

A **Reset LED**— indicates power status and reset status of the device (see **Reset Modes** on page 30).

B **Reset button**— initiates one of three reset modes for the unit (see **Reset Modes** on page 30).

C **Menu button**— activates the **Setup Menu** (see page 13).

D **USB connectors** — two high speed USB 2.0 connectors for peripheral controls.

E **Audio output** — a 3.5 mm headphone jack provides local line level audio output from the touchpanel.

F **XTP/PoE/LAN input** — accepts an input from a LAN or an Extron XTP transmitter. Use Cat 5e or greater cable terminated with an RJ-45 connector. Extron recommends using XTP DTP 24 SF/UTP cable for the best performance. At a minimum, Extron recommends 24 AWG, solid conductor, STP cable with a minimum bandwidth of 400 MHz.

An Extron IPL Pro Control Processor must also be connected to the same network domain as the TouchLink Pro touchpanel. See www.extron.com for a list of suggested models.

The network port has two LEDs. The green LED lights steadily to indicate that the touchpanel is connected correctly to a network. The yellow LED flashes to indicate that data is being passed to or from the touchpanel.

These touchpanels can use either a 12 VDC desktop power supply or a Power over Ethernet power injector.

The Extron PI 140 power injector is provided with the TLP Pro 1720 series touchpanels. Do not use a different power injector with these models.

ATTENTION:

- Do not connect either power supply before reading the Attention notifications on [page 10](#) or [page 11](#).
- Ne branchez pas de sources d'alimentation externes avant d'avoir lu les mises en garde dans la section « Power Supply » sur [page 10](#) ou [page 11](#).

- If you are using a **12V power input** (see page 10), connect the touchpanel directly to an XTP source or to a LAN.
- To use a PoE power injector, connect the touchpanel as shown in figure 4, below. You must use the PI 140 (shown in figure 4) with the TLP Pro 1720 series touchpanels and Extron recommends using this power injector with the TLP Pro 1220 and TLP Pro 1520 series touchpanels.
- Limit the use to no more than two pass-through points, which may include patch points, punch down connectors, couplers and power injectors. If these pass-through points are required, use shielded couplers and punch-down connectors

NOTES: When using shielded twisted pair cable in bundles or conduits, consider the following:

- Do not exceed 40% fill capacity in conduits.
- Do not comb the cable for the first 20 meters, where cables are straightened, aligned, and secured in tight bundles.
- Loosely place cables and limit the use of tie wraps or hook-and-loop fasteners.
- Keep twisted pair cables separate from AC power cables.

To use a PoE power injector — connect an Ethernet cable to the power supply and a switch or router. This cable carries network information from the switch or router to the power supply input. A second cable carries the network information and 56 VDC from the power supply to the touchpanel. Connect the IEC power cord to a convenient 100 VAC to 240 VAC, 50-60 Hz power source.

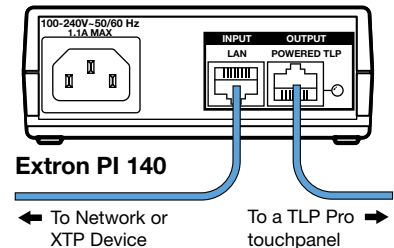

Figure 4. Connecting the Power Injector

ATTENTION:

- Always use a power supply provided by or specified by Extron. Use of an unauthorized power supply voids all regulatory compliance certification and may cause damage to the supply and the end product.
- Utilisez toujours une source d'alimentation fournie ou recommandée par Extron. L'utilisation d'une source d'alimentation non autorisée annule toute conformité réglementaire et peut endommager la source d'alimentation ainsi que le produit final.
- The installation must always be in accordance with the applicable provisions of National Electrical Code ANSI/NFPA 70, article 725 and the Canadian Electrical Code part 1, section 16.
- Cette installation doit toujours être en accord avec les mesures qui s'applique au National Electrical Code ANSI/NFPA 70, article 725, et au Canadian Electrical Code, partie 1, section 16.
- These products are intended for use with a UL Listed power source marked "Class 2" or "LPS" and rated 12 VDC, minimum 3.0 A. or 56 VDC (PoE), minimum 0.8 A.
- Ces produits sont destinés à une utilisation avec une source d'alimentation listée UL avec l'appellation « Classe 2 » ou « LPS » et normée 12 Vcc, 3,0 A minimum ou 56 Vcc (PoE), 0,8 A minimum.
- The power supply shall not be permanently fixed to the building structure or similar structure.
- La source d'alimentation ne devra pas être fixée de façon permanente à une structure de bâtiment ou à une structure similaire.
- The touchpanels are intended for connection to a Power over Ethernet circuit for intra-building use only and are considered to be part of a Network Environment 0 per IEC TR62101.
- Les écrans tactiles sont conçus pour une connexion à un circuit PoE pour une utilisation intérieure seulement et est considéré comme faisant partie d'un environnement réseau 0 par IEC TR62101.

G **HDMI input** (see figure 3 on page 8) — One female HDMI connector for video input.

H **12V Power input** (see figure 3 on page 8) — power supplies must be purchased separately.

Connect a 12 VDC, 3.0 A power supply to the rear panel power receptacle. Extron recommends using the PS 1230 power supply

WARNING: The two power cord wires must be kept separate while the power supply is plugged in. Remove power before wiring.

AVERTISSEMENT : Les deux cordons d'alimentation doivent être tenus à l'écart l'un de l'autre quand l'alimentation est branchée. Couper l'alimentation avant de faire l'installation électrique.

NOTES:

- The TLP Pro 1220 and 1520 series touchpanels ship without a power supply. Either the 12 VDC power supply or the power injector must be purchased separately.
- Power supplies for the TG models use DC plugs. Power supplies for the MG models use captive screw connectors.

ATTENTION:

- Always use a power supply provided by or specified by Extron. Use of an unauthorized power supply voids all regulatory compliance certification and may cause damage to the supply and the end product.
- Utilisez toujours une source d'alimentation fournie ou recommandée par Extron. L'utilisation d'une source d'alimentation non autorisée annule toute conformité réglementaire et peut endommager la source d'alimentation ainsi que le produit final.
- The installation must always be in accordance with the applicable provisions of National Electrical Code ANSI/NFPA 70, article 725 and the Canadian Electrical Code part 1, section 16.
- Cette installation doit toujours être en accord avec les mesures qui s'applique au National Electrical Code ANSI/NFPA 70, article 725, et au Canadian Electrical Code, partie 1, section 16.
- These products are intended for use with a UL Listed power source marked "Class 2" or "LPS" and rated 12 VDC, minimum 3.0 A. or 56 VDC (PoE), minimum 0.8 A.
- Ces produits sont destinés à une utilisation avec une source d'alimentation listée UL avec l'appellation « Classe 2 » ou « LPS » et normée 12 Vcc, 3,0 A minimum ou 56 Vcc (PoE), 0,8 A minimum.
- The power supply shall not be permanently fixed to the building structure or similar structure.
- La source d'alimentation ne devra pas être fixée de façon permanente à une structure de bâtiment ou à une structure similaire.
- Unless otherwise stated, the AC/DC adapters are not suitable for use in air handling spaces or in wall cavities. The power supply is to be located within the same vicinity as the Extron AV processing equipment in an ordinary location, Pollution Degree 2, secured to the equipment rack within the dedicated closet, podium, or desk.
- Sauf mention contraire, les adaptateurs AC/DC ne sont pas appropriés pour une utilisation dans les espaces d'aération ou dans les cavités murales. La source d'alimentation doit être située à proximité de l'équipement de traitement audiovisuel dans un endroit ordinaire, avec un degré 2 de pollution, fixé à un équipement de rack à l'intérieur d'un placard, d'une estrade, ou d'un bureau.
- Extron power supplies are certified to UL/CSA 60950-1 and are classified as LPS (Limited Power Source). Use of a non-LPS or unlisted power supply will void all regulatory compliance certification.
- Les sources d'alimentation Extron sont qualifiées UL/CSA 60950-1 et sont classées LPS (Limited Power Source). L'utilisation d'une source d'alimentation non-listée ou non-listée LPS annulera toute certification de conformité réglementaire.
- The length of the exposed wires in the stripping process is critical. The ideal length is 3/16 inches (5 mm). If they are any longer, the exposed wires may touch, causing a short circuit between them. If they are any shorter, the wires can be easily pulled out even if tightly fastened by the captive screws.
- La longueur des câbles exposés est primordiale lorsque l'on entreprend de les dénuder. La longueur idéale est de 5 mm (3/16 inches). S'ils sont un peu plus longs, les câbles exposés pourraient se toucher et provoquer un court circuit. S'ils sont un peu plus courts, ils pourraient sortir, même s'ils sont attachés par les vis captives.
- Do not tin the wire leads before installing into the connector. Tinned wires are not as secure in the connector and could be pulled out.
- Ne pas étamer les conducteurs avant de les insérer dans le connecteur. Les câbles étamés ne sont pas aussi bien fixés dans le connecteur et pourraient être retirés.

- ❶ **Mounting notches** (2) (MG models only) — lower these notches over the hooks at the top of the mounting frame (see **Wall Mounting** on page 25).
- ❷ **Mounting screws** (2) (MG models only) — for securing the bottom of the touchpanel to the mounting frame (see **Wall Mounting**).
- ❸ **Rear status light** (TG models only) — one LED light bar that can be programmed to provide system feedback.
 - Light red or green
 - Blink or light continuously

TG models have a status light on both the front and rear panels. Both lights provide the same information and cannot be programmed individually.

For information about programming this light, see the *Global Configurator Help File*.
- ❹ **VESA mounting holes** (4) (TG models only)— VESA FDMI Type D 100 mm mounting pattern standard can be used for VESA mounting (see **VESA Mounting** on page 29).
- ❺ **Base attachment hinges** (2) (TG models only)— Secure the base to the touchpanel. For **VESA Mounting**, remove the base by unscrewing the hinges.

Routing Cables (TG Models)

Organize cables behind the rear and base covers for a more esthetically appealing appearance. The TLP Pro 1520TG is shown below but the TLP Pro 1220TG and TLP Pro 1720TG are similar.

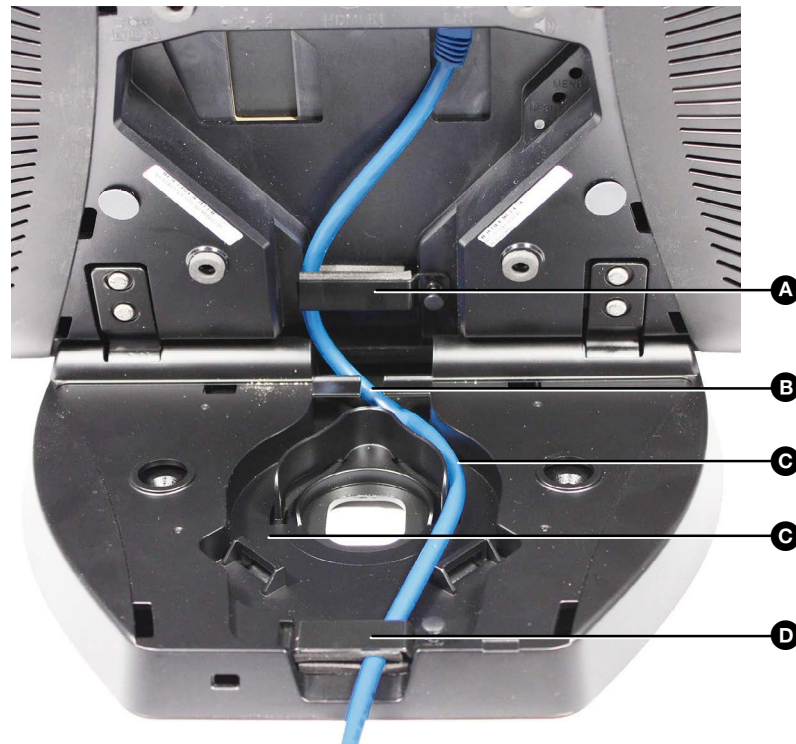

Figure 5. TLP Pro 1520TG Cable Organization

1. If necessary, remove the rear and base covers and connect the cables as required.
2. Run the cables through the clamp on the back (❶), and through the restricted gap where the base and back meet (❷).
3. Run the cables through the raceways on either side of the center hole (❸), and through the clamp at the back of the base (❹).
Multiple cables, can be loosely bundled to keep them organized.
4. Move the cable clamp back into position and press the top to secure it in place
5. Put back the rear and base covers. The base cover must be inserted before the rear cover.

Setup Menu

The TLP Pro 1220, 1520, and 1720 series touchpanels can be set up by using the on-screen setup menu. This section provides information about accessing the Setup menu and the six sub-menus:

- [Setup Menu](#)
- [Status Screen](#)
- [Network Screen](#)
- [Display Screen](#)
- [Audio Screen](#)
- [Input Screen](#)
- [Advanced Screen](#)

Setup Menu

To open the setup menu, press the **Menu** button, which is located on the rear panel (see [figure 3](#), **C** on page 8). In addition, the TLP Pro 1220MG, 1520MG, and 1720MG have a recessed button, which can be accessed from under the front panel (see [figure 2](#), **G** on page 6). Use a small screwdriver to press the button.

The menu opens at the **Status** screen. There are six different buttons in the navigation panel at the top of the screen. These open the following screens:

- [Status Screen](#)
- [Network Screen](#)
- [Display Screen](#)
- [Audio Screen](#)
- [Input Screen](#)
- [Advanced Screen](#)

The button for the selected screen is yellow; the buttons for the remaining screens are black.

There is also a red **Exit** button in the top right corner of the screen. Pressing this button applies and saves any changes and closes the menu screens.

In this section, the figures show the screens for the TLP Pro 1220MG. The screens for the other touchpanels are similar.

Status Screen

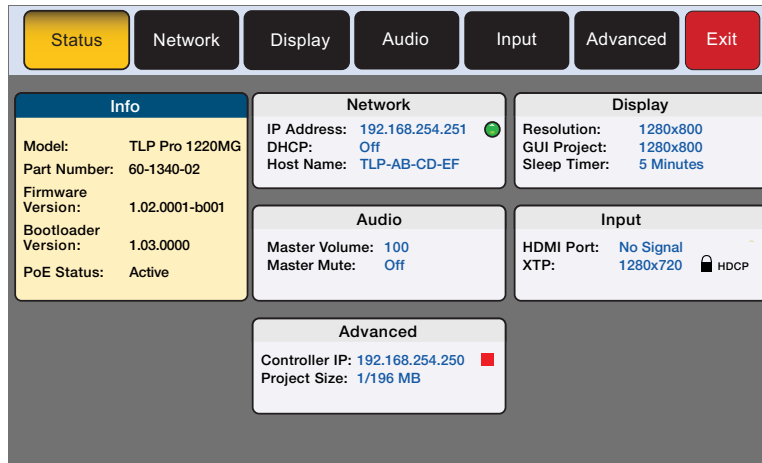

Figure 6. Status Screen

The **Status** screen is read-only. The **Info** panel provides basic information about the touchpanel. Each of the other five panels shows a summary of the information on the other screens. No values can be changed from this screen but pressing any of those five panels opens the corresponding screen in exactly the same way as pressing the buttons in the top navigation bar.

The green bubble shown in the **Network** panel indicates that there is a network connection. The red square shown in the **Advanced** panel indicates that no control processor is connected.

Network Screen

The **Network** screen allows you to set the **DHCP** status and, if DHCP is set to **Off**, the network addresses for the touchpanel. Verify with your network administrator whether the IP address for the touchpanel is assigned by DHCP or set manually. If it is set manually, you need to obtain an IP address, a subnet mask, a gateway address, and a Domain Name Server (DNS) IP address from the network administrator.

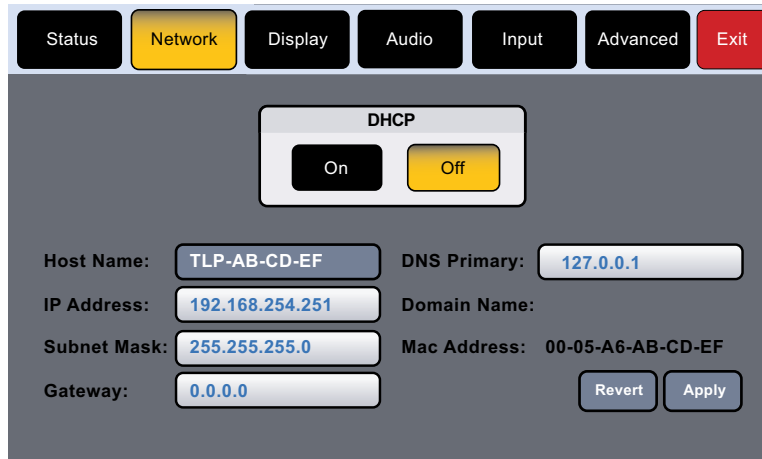

Figure 7. Network Screen

1. If network settings are assigned by DHCP, press **On**. The selected button is highlighted in yellow. If DHCP is selected, you can only set the **Host Name**. All other values are set by the DHCP server.

If IP addresses are assigned manually, press **Off**. When DHCP is off, all values except the **Host Name** can be edited.

2. Edit the **Host Name** by pressing that button. A keypad opens:



Figure 8. Alphanumeric Keypad

- Use the keypad to enter a new name, which appears in the **Host Name** text box.
 - Use the backspace character () to delete existing characters.
 - The **right** and **left arrows** move the cursor inside the **Host Name** text box.
 - Click the **Shift** key to toggle between upper and lower case letters.
 - Press **Enter** to save the new name.
3. If DHCP is disabled, set the unit **IP address**, **subnet mask**, **gateway address**, and **DNS** server address.
 - a. Press the button for the address to be edited. A screen opens, showing the address and a numerical keypad.

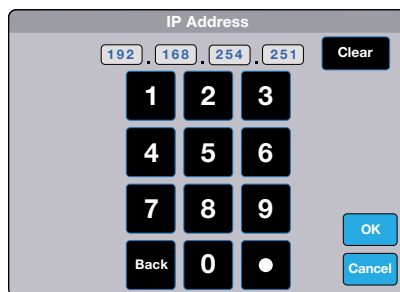

Figure 9. Numeric Pad for Setting IP Addresses

- b. Press **Clear** to remove the old address. If you start typing without pressing **Clear**, the first octet is over-written and the other octets remain the same.
- c. Press any octet button to highlight and start editing it.
- d. Enter the 3-digit value for that octet (leading zeroes in the octet are ignored).

NOTE: Octets can have any value between 0 and 255. You cannot enter an invalid number. For example, if you try to enter 892, you are able to enter the 89 but the 2 cannot be entered.

Click **Back** to delete the last digit. If no value has been entered for the selected octet, pressing **Back** moves the cursor back to the previous octet and deletes the last digit of that octet.

- e. Press the next octet button and enter a value.
- f. Repeat steps 3c through 3e to enter values for all four octets.
- g. Press **OK** to save the changes and return to the Network screen or press **Cancel** to return to the Network screen without saving the changes.

4. If you have changed any of the values in the **Network** screen, the background color of the button changes to blue. Press **Apply** to apply the new values or press **Revert** to return to the previous values without saving the changes. The button returns to gray.

0.0.0.10

If you have not made any changes, the **Apply** and **Revert** buttons are unavailable for selection.

Display Screen

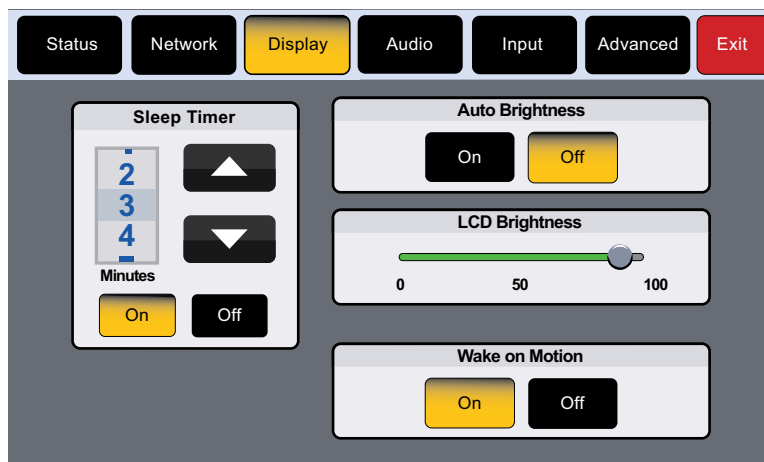

Figure 10. Display Screen

The **Display** screen allows you to set the **Sleep Timer**, **Auto Brightness**, **LCD Brightness**, and **Wake on Motion**.

- **Sleep Timer** — determines how long the panel is inactive before it enters sleep mode, when the screen goes dark to save power. Select either **On** or **Off**. If the sleep timer is **On**, use the arrows to adjust the value between **1** and **120** minutes.
- **Auto Brightness** — provides a suitable amount of backlighting that is automatically calculated from the amount of ambient light detected by the light sensor (see [figure 2](#), **C**, on page 6).
- **LCD Brightness** — allows you to adjust the screen brightness, using the slider control.
- **Wake on Motion** — activates the panel from Sleep mode when motion is detected near the unit. Select either **On** or **Off**.

Audio Screen

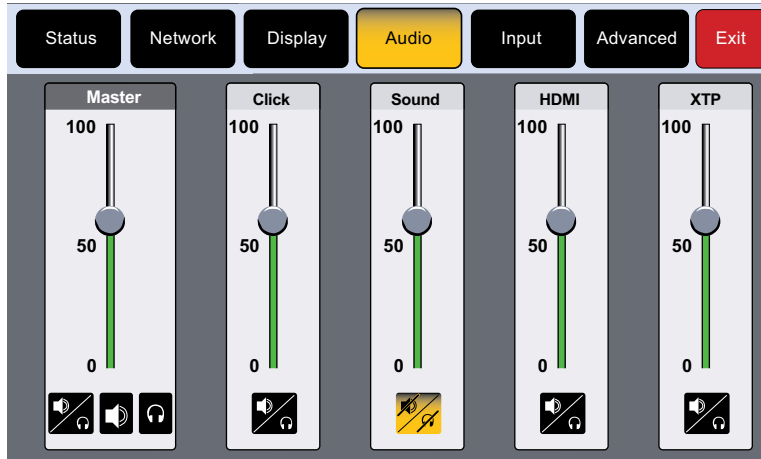

Figure 11. Audio Screen

On the **Audio** screen, use the slider controls to adjust the **Master**, **Click**, **Sound**, **HDMI**, and **XTP** volume settings.

- The **Master** panel allows you to click on the appropriate icon to set whether the audio is heard through the speakers, headphones, or both. It also sets the maximum volume threshold for all the other sound volume settings. For example, if the master volume is set to **80** (80 percent of maximum), when the HDMI volume is set to **50**, it is equivalent to only 40 percent of maximum (50 percent of 80 percent).
- **Click** sets the volume for audible feedback that accompanies events such as a screen button being pressed.
- **Sound** sets the volume of audio from any audio file playback.
- **HDMI** sets the volume of the HDMI input.
- **XTP** sets the volume of the XTP input.

Click on the speaker and headphones icon at the bottom of each panel to toggle between audio on and audio mute. The **Sound** audio is muted in figure 11.

Input Screen

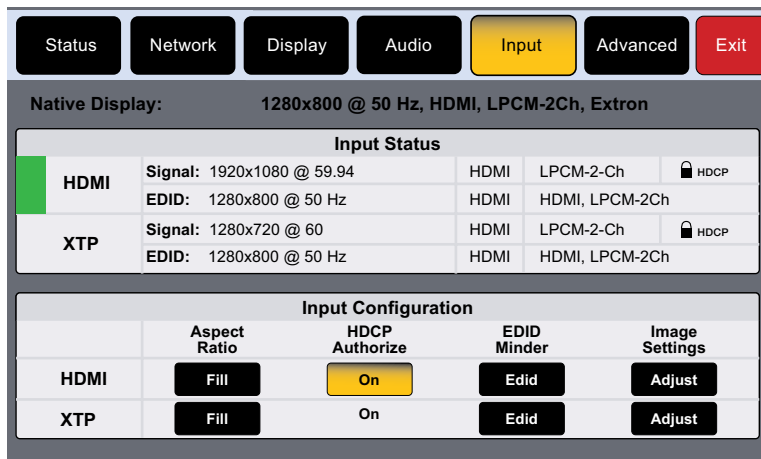

Figure 12. Input Screen

The **Input** screen provides information about the video input signal status and allows configuration of the input signal.

At the top of the screen the native display EDID information is shown. For the TLP Pro 1220MG, this is **1280x800 @ 50 Hz, HDMI, LPCM-2Ch**.

The upper panel shows read-only information about the input signal status. The green bar indicates whether the current input is HDMI or XTP. In figure 12, on the previous page, the input is HDMI. The XTP input status information is obtained from the last XTP input signal.

The lower panel allows adjustments to the input configuration.

- **Aspect Ratio:** Press this button to toggle between **Fill**, which stretches the image so that it fills the entire screen, and **Follow**, which maintains the aspect ratio of the input signal.
- **HDCP Authorization:** Press the button to toggle between **On** (default) and **Off**. When HDCP Authorize is **On**, HDCP-encrypted input signals pass to the screen.
- **EDID Minder:** Press the **EDID** button to toggle between using the EDID of the touchpanel (1280x800 @ 50Hz for the TLP Pro 1220MG) or setting a resolution and refresh rate. The button is black if the native display is used and turns yellow if you are setting the EDID manually.

Pressing the button opens the EDID Minder window. When setting the EDID manually, only the Resolution window is initially populated. Once the resolution is selected, the available refresh rates for that resolution are displayed. When both the resolution and refresh rate are selected, press **Apply**.

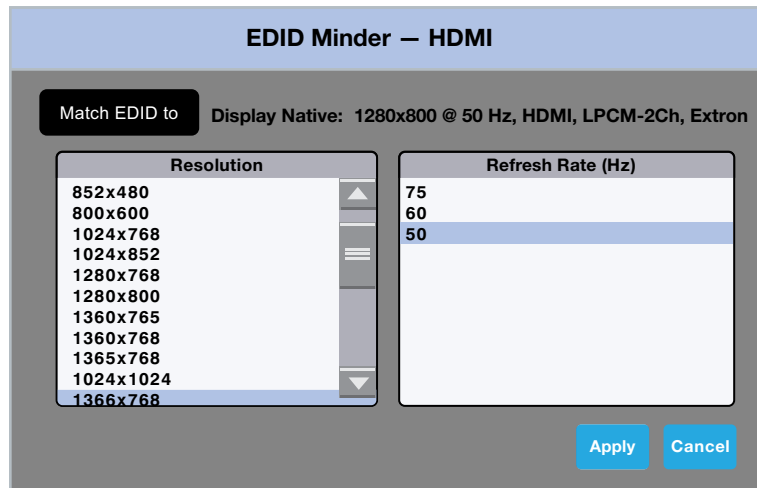

Figure 13. EDID Minder

- **Image Settings:** Press the **Adjust** button to open the Image Settings window. Select the input (**HDMI** or **XTP**), or adjust **Brightness**, **Contrast**, **Detail**, and **Overscan**.

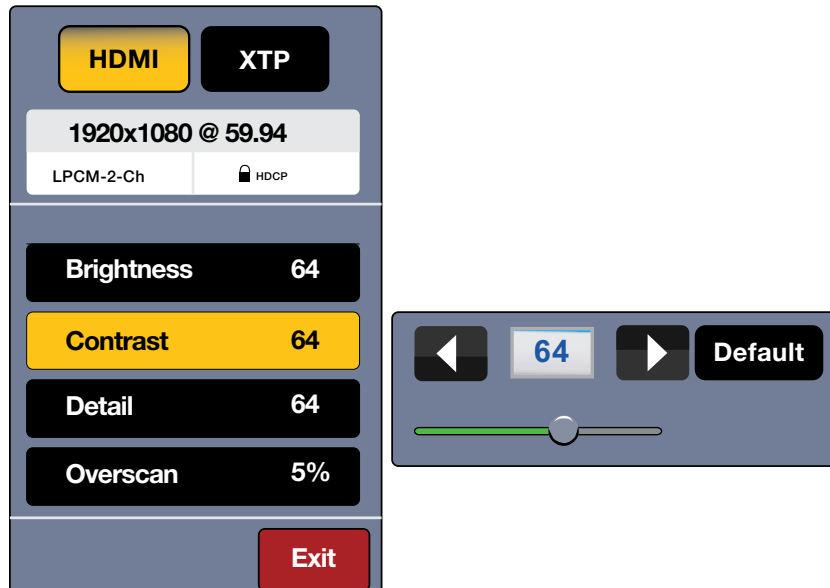

Figure 14. Image Settings

1. Select the video input by pressing the appropriate button (**HDMI** or **XTP**).
The EDID information is shown in a read-only panel.
2. To adjust **Brightness**, **Contrast**, **Detail**, or **Overscan**, press the appropriate button. A small window opens to the right of the screen. For **Brightness**, **Contrast**, and **Detail**, the window shows the current value with right and left arrows to increment or decrement the value. To change the value more quickly, use the slider underneath.
To reset the value to default, press the default value. The default value for **Brightness**, **Contrast**, and **Detail** is **64**. All three parameters can be adjusted to any value between **1** and **127**.
3. Press **Overscan**. A small window opens offering the options **0%**, **2.5%**, and **5%**. The default setting is **5%**.
4. Press **Exit** to save the changes and return to the **Input** screen.

Advanced Screen

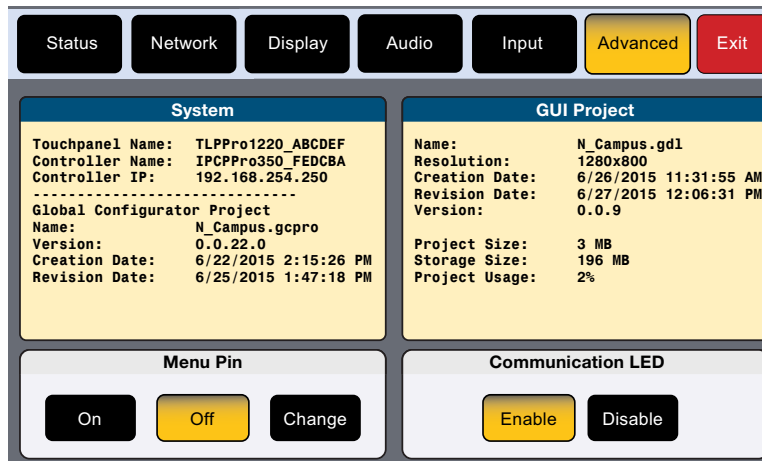

Figure 15. Advanced Screen

The System and GUI Project panels are read only, providing information about the system.

Menu PIN

Press **Change** to open the **PIN Setup** window. The PIN setup options allow you to enable, disable, or change the setup menu PIN. The PIN is a 4-digit number. Each digit can have any value from **0-9**.

1. Press a number on the keypad. A blue circle appears in the first box.

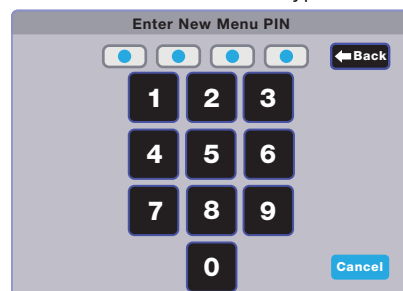

Figure 16. Numeric Keypad for Setting PIN

2. Select the other three digits for the pins. The fourth circle appears momentarily and then the screen changes to **Confirm New Menu Pin**.
3. Enter the PIN a second time. When the PIN entered on the second occasion matches the PIN entered on the first occasion, the PIN is set and the dialog closes.

Communication LED

The LED (see [figure 2](#), **A** on page 6) can be enabled or disabled.

Configuration Software

This section of the user guide provides information about:

- [Configuration Software](#)
- [Install GUI Designer, Global Configurator, and Toolbelt](#)
- [TLP Pro 1220, 1520, and 1720 Series Web Page](#)
- [Updating the Firmware](#)

Configuration Software

Use Toolbelt to provide device information, firmware updates, and configuration of network settings, system utilities (reset, reboot), and user management (username and password) for TouchLink Pro devices.

Use GUI Designer and Global Configurator Plus and Professional to design a graphical user interface (GUI) for the TouchLink Pro touchpanel:

- 1.** Design the layout of the screen text and graphics using GUI Designer, which is a Windows-based application. You can either customize an existing template or create an entirely new interface. GUI Designer offers several templates.
- 2.** After the user interface has been designed, the project is saved, built, and imported into Global Configurator Plus and Professional.
- 3.** Use Global Configurator Plus and Professional to assign functions to the text and graphics of the interface.
- 4.** After assigning the control functions, the project is rebuilt and uploaded to the control processor and touchpanel.

The GUI Designer and the Global Configurator Plus and Professional programs provide versatility and adaptability for configuration and control of an AV system as it grows and evolves.

Install GUI Designer, Global Configurator, and Toolbelt

NOTE: Use GUI Designer and Global Configurator Plus and Professional to configure the TLP Pro touchpanel.

GUI Designer, Global Configurator, and Toolbelt can be downloaded from www.extron.com.

1. Select the **Download** tab (1).
2. Click the **Software** (2) option in the sidebar at the left.

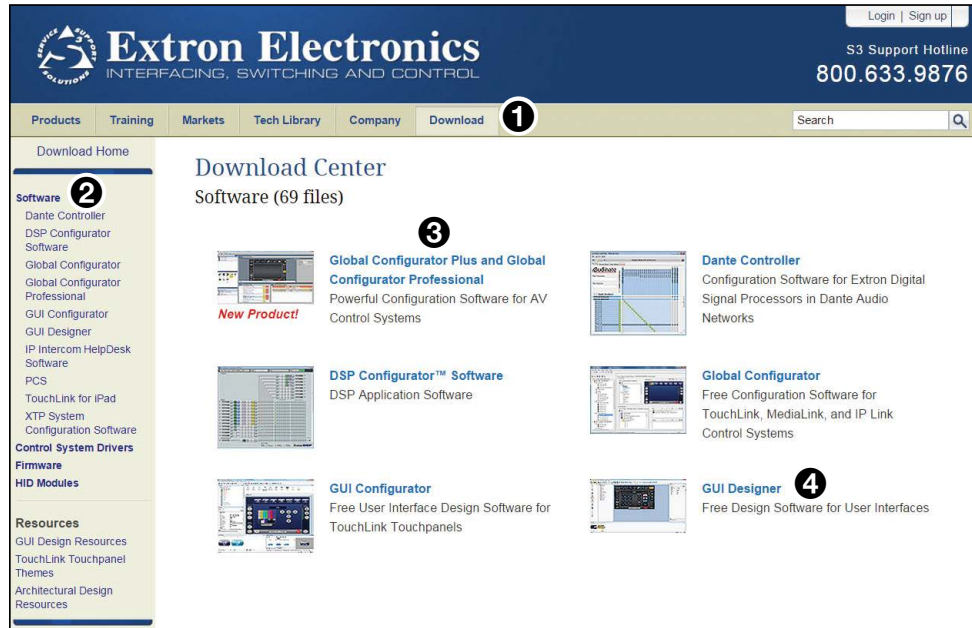

Figure 17. Software Downloads from the Extron Website

3. Select the link to Global Configurator Plus and Professional (3), GUI Designer (4), or Toolbelt. If they are not available on the Software home page, scroll down the page to the alphabetic menu bar and click on the appropriate initial letter.

NOTE: If you select Global Configurator Plus and Professional, there is a check box that allows you to download Toolbelt at the same time.

4. If necessary, scroll down the list of options to the desired software.
5. Click the **Download** button next to the program and follow the on-screen instructions.

NOTES:

- You need an Extron Insider account to run Global Configurator Plus and Professional. To obtain one, contact the Extron Sales Department.
- Ensure you are downloading Global Configurator Plus and Professional.

Using the Software

GUI Designer

Use the GUI Designer software to design the screen layout for the touchpanel. See the *GUI Designer Help* file for step-by-step instructions and more detailed information.

Global Configurator

Use the Global Configurator software to set up and configure the control processor and the touchpanel. See the *Global Configurator Help File* for step-by-step instructions and more detailed information. The *Global Configurator Help File* also includes an introduction to the software and sections on how to start and configure a project.

Toolbelt

Use the Toolbelt software for device discovery, device information, firmware updates, and configuration of network settings, system utilities, and user management for TouchLink Pro devices.

TLP Pro 1220, 1520, and 1720 Series Web Page

To access the touchpanel default web page, enter the IP address of the unit into the web browser of a PC connected to the same subnet. A dialog opens asking for your user name and password. By default, the user name is `admin` and the password is `extron` (both user name and password are all lower case).

- There is a single page, most of which is read-only, providing general and network information about the unit. Use the **Setup Menu** (see page 13) or Toolbelt to configure the touchpanel network settings.
- Click **License Information** to see information about **Network Port Requirements and Licensed Third-Party Software Used by the Touchpanels** (see page 30).
- Use the **Firmware Uploader** panel to upgrade the unit firmware (see **Updating Firmware Using the Touchpanel Web Page** on the following page).

Figure 18 shows the TLP Pro 1520TG web page. The web page for the other touchpanels is similar.

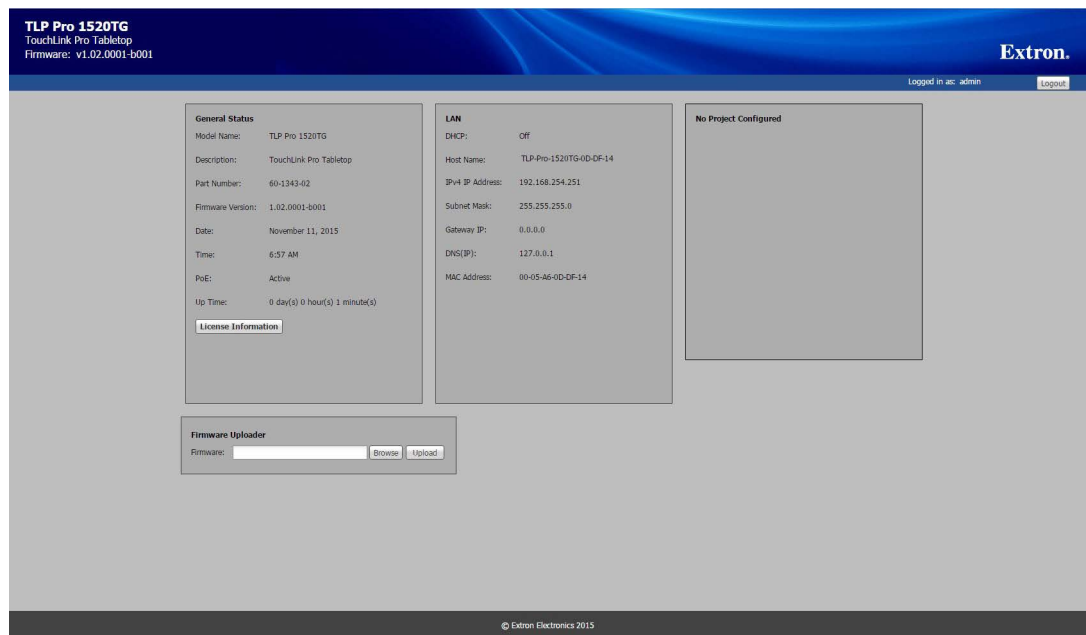

Figure 18. TLP Pro 1520TG Web Page

Updating the Firmware

Firmware for all the touchpanels can be upgraded using Toolbelt or the touchpanel web page. Before starting, consult your IT team and ensure that the touchpanel has a unique IP address.

Downloading Firmware

1. Power on a computer that is connected to the same network as the touchpanel.
2. On the Extron website, click **Download** in the menu bar along the top of the page (see figure 19, ❶).

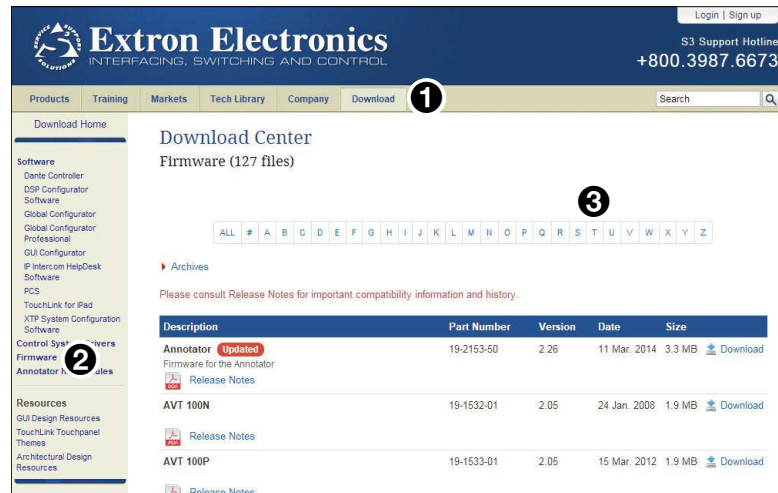

Figure 19. Firmware Download Center

3. Click **Firmware** in the menu bar in the left side bar (❷).
4. Click the letter **T** from the list of letters (❸).
5. Scroll down the page until you find the firmware for your model.
6. Click **Release Notes** for more information about the firmware.
7. Click **Download**.
8. Enter the required information and press the download button. An executable (.exe) file is downloaded to your computer. Run this program to place the firmware on your computer for future use. Make a note of the folder where the firmware is saved.

Updating Firmware Using the Touchpanel Web Page

1. If you have not already done so, download the firmware file to a computer on the same network as the touchpanel (see the previous section).
2. Open the touchpanel web page (see the previous page).

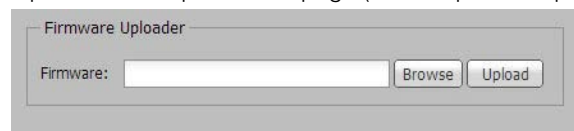

Figure 20. Touchpanel Web Page: Firmware Uploader

3. Click **Browse** and navigate to the firmware location. Select the firmware file and click **Open**.
4. Click **Upload**. The firmware file is uploaded to the touchpanel. Follow the on-screen instructions.

Updating Firmware Using Toolbelt

For complete information about using Toolbelt to update the touchpanel firmware, see the *Toolbelt Help File*.

Mounting

This section outlines the various options for:

- **Mounting the TLP Pro 1220MG, 1520MG, and 1720MG**
 - **Rack Mounting**
 - **Wall Mounting**
- **Mounting the TLP Pro 1220TG, 1520TG, and 1720TG**
 - **Desktop Mounting**
 - **VESA Mounting**

Mounting the TLP Pro 1220MG, 1520MG, and 1720MG

Rack Mounting

These touchpanels can be mounted in any standard 19-inch equipment rack, using the optional rack mounting kit.

- **TLP Pro 1220MG:** RM 2 kit
- **TLP Pro 1520MG:** RM 3 kit
- **TLP Pro 1720MG:** RM 3 kit

Read the Underwriters Laboratories Guidelines for Rack Mounting below and follow the instructions provided with the appropriate kit.

Underwriters Laboratories Guidelines for Rack Mounting

The following Underwriters Laboratories (UL) guidelines are relevant to the safe installation of these products in a rack:

- **Elevated operating ambient temperature** — If the unit is installed in a closed or multi-unit rack assembly, the operating ambient temperature of the rack environment may be greater than room ambient temperature. Therefore, install the equipment in an environment compatible with the maximum ambient temperature (T_{ma}: +122 °F, +50 °C) specified by Extron.
- **Reduced air flow** — Install the equipment in the rack so that the equipment gets adequate air flow for safe operation.
- **Mechanical loading** — Mount the equipment in the rack so that uneven mechanical loading does not create a hazardous condition.
- **Circuit overloading** — Connect the equipment to the supply circuit and consider the effect that circuit overloading might have on overcurrent protection and supply wiring. Give appropriate consideration to the equipment nameplate ratings when addressing this concern.
- **Reliable earthing (grounding)** — Maintain reliable grounding of rack-mounted equipment. Pay particular attention to supply connections other than direct connections to the branch circuit (such as the use of power strips).

Wall Mounting

The touchpanels can be mounted into drywall. The diagram in this section shows the TLP Pro 1520MG. Mount the TLP Pro 1220MG and TLP Pro 1720MG in the same way.

ATTENTION:

- Do not install the TLP Pro 1220MG, the TLP Pro 1520MG, or the TLP Pro 1720MG in a fire resistant rated wall or partition assembly.
- Ne pas installer le TLP Pro 1220MG, le TLP Pro 1520MG, ou le TLP Pro 1720MG dans un mur résistant au feu ou une cloison.
- All structural steps and electrical installation must be performed by qualified personnel in accordance with local and national building codes and electrical codes.
- Toute étape structurelle et installation électrique, doit être effectuée par un personnel qualifié, conformément aux codes du bâtiment, aux codes incendie et sécurité, et aux codes électriques, locaux et nationaux.

Some local building codes require the touchpanel to be mounted in a wall box such as the Extron BB 700M (see [Mounting with a wall box](#) on the following page).

If local codes permit, you may mount the touchpanel without the wall box (see [Mounting without a wall box](#) on page 27).

Mounting with a wall box

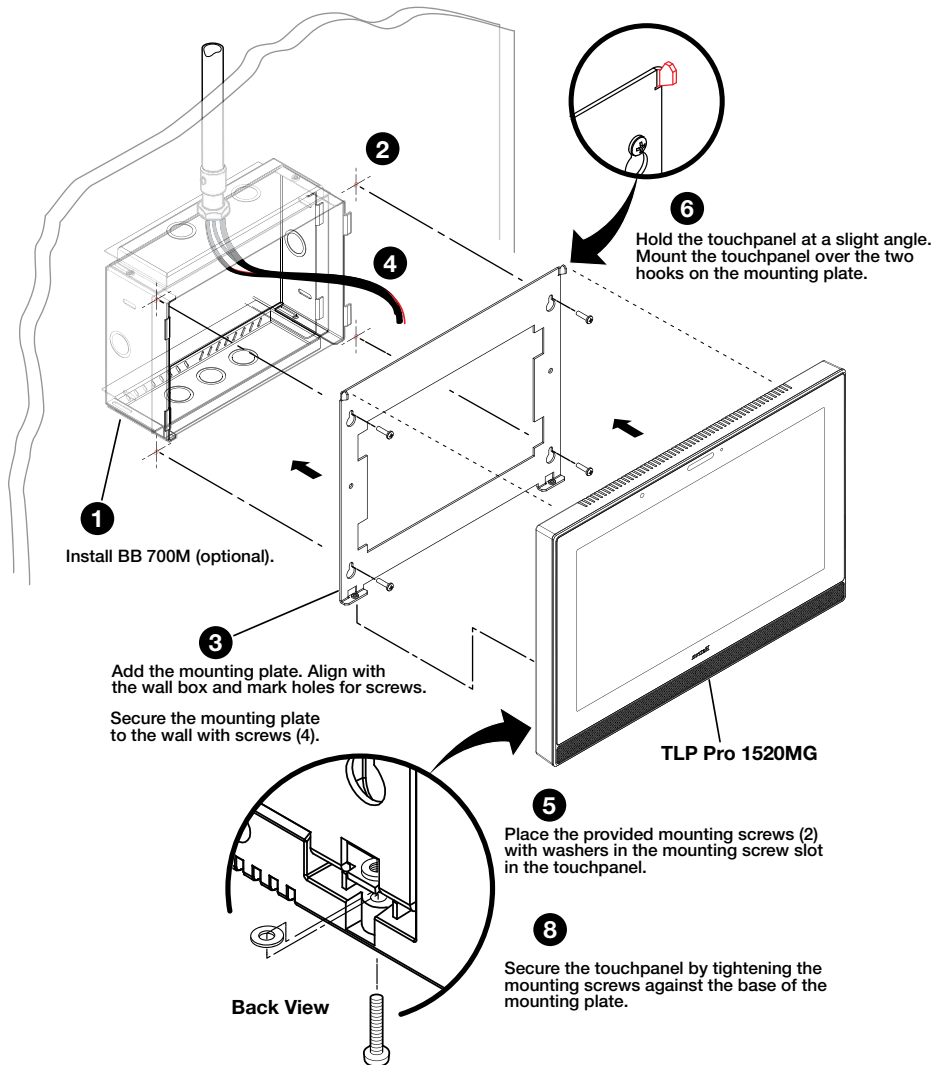

Figure 21. Wall Mounting the TLP Pro 1520MG with the BB 700M

The TLP Pro 1220MG, 1520MG, and 1720MG can all be mounted using the BB 700M wall box.

1. Cut a hole in the drywall, 9.55 inches (24.26 cm) wide x 6.55 inches (16.64 cm) high, and install the BB 700M back box (must be purchased separately), as described in the *BB 700M Installation Guide* (see www.extron.com).
2. Place the metal mounting plate against the wall, mark the four mounting holes, and drill four pilot holes.
3. Secure the mounting plate with four #10 screws.
4. Run and connect cables to the rear of the touchpanel (see [TLP Pro 1220, 1520, and 1720 Series Rear Panel Features](#) on page 8).
5. Insert the two provided Phillips pan head #6-32 x 3/4 inch length screws with washers in the mounting screw slot (see [figure 3, 1](#) on page 8).
6. Hold the touchpanel at a slight angle and lower the notches at the top of the back panel (see [figure 3, 1](#)) over the hooks of the mounting plate.
7. Swing the bottom of the touchpanel inwards so that it lies flat against the mounting plate with the tongue at the bottom of the mounting plate sitting in a groove in the bottom of the touchpanel.
8. Secure the touchpanel to the mounting plate with the mounting screws.

Mounting without a wall box

This procedure can be adapted to mount the touchpanel in furniture, such as a lectern.

1. Download the cut-out template for your touchpanel from www.extron.com. Print it at 100% (no scaling).
2. Use the template to mark the wall, cut the hole, and drill the four pilot holes.
The size of the cut-out hole is 9.25 inches (23.50 cm) wide x 6.25 inches (15.88 cm) high for the TLP Pro 1220MG, 1520MG, and 1720MG.
3. Secure the mounting plate and complete the installation, as described in [steps 3-8](#) on the previous page.

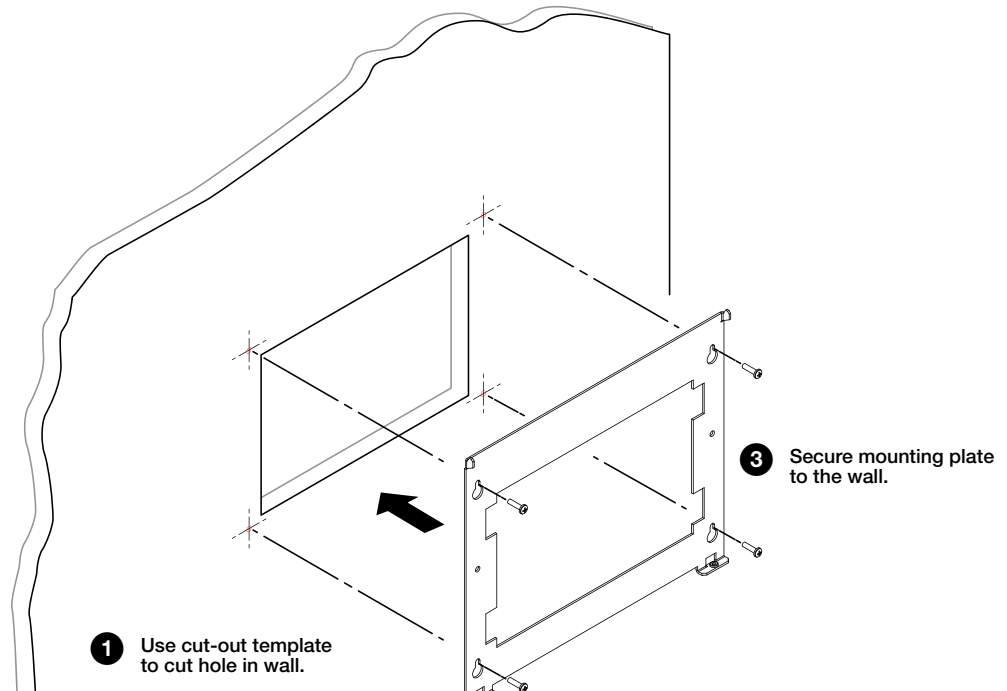

Figure 22. Mounting Without a Wall Box.

Mounting the TLP Pro 1220TG, 1520TG, and 1720TG

Removing the Back and Base Covers

Some of these procedures require the back and base covers to be removed. You must remove the back cover before you can remove the base cover.



Figure 23. Remove the Back and Base Covers

1. Use the provided Extron removal tool. There is one notch on each side of the back cover (figure 23, **1**). Insert the tool into the notch to release the catch.
2. Use the removal tool to remove the base cover. There are two notches at the back of the base (**2**).

Desktop Mounting

The TLP Pro 1220TG, TLP Pro 1520TG, and TLP Pro 1720TG come assembled with stands that allow the units to be placed on any suitable flat surface (for example a desk, table, or lectern).

Placement without a Mounting Kit

Figure 24 shows the base of the TLP Pro 1220TG, with the cover removed to indicate the position of the mounting holes. The bases of the TLP Pro 1520 TG and TLP Pro 1720TG are similar and the spacing of the mounting holes (figure 24, **1**) is identical.

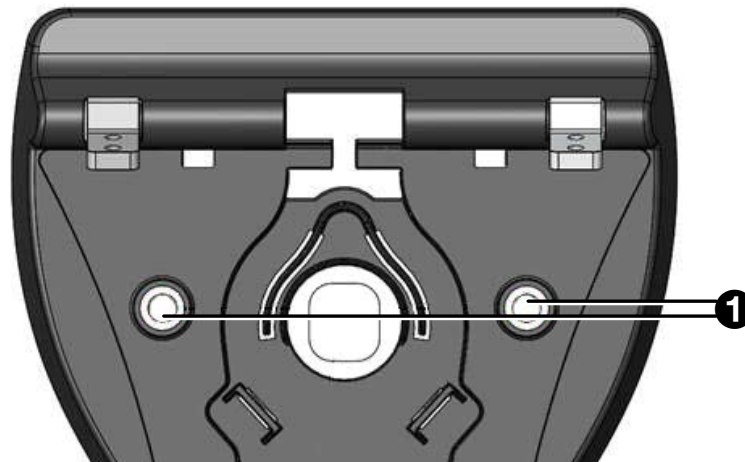

Figure 24. TLP Pro 1220TG Base, Showing Mounting Holes

1. Mark the location of two mounting holes, 4.96" (126.0 mm) apart. This measurement is the same for the TLP Pro 1220TG, TLP Pro 1520TG, and TLP Pro 1720TG.

2. Drill two pilot holes into the desktop.
3. Remove the cover of the touchpanel base.
4. Insert two #10 flat-head wood screws (not provided) through the touchpanel and align them with the two pilot holes.
5. Secure the touchpanel to the tabletop.
6. Replace the cover to the base.

Placement with a Kensington Security Lock



Figure 25. TLP Pro 1220TG Base, Showing Kensington Security Slot

For added security, attach a Kensington Security Lock (not provided) to the metal-reinforced slot on the rear edge of the base. Figure 25 shows the rear edge of the TLP Pro 1220TG base, but the TLP Pro 1520TG and TLP Pro 1720TG bases are very similar.

Follow the instructions that are provided by the manufacturer to install the lock.

Placement with a SMA-1 swivel mount adapter

Both touchpanels can also be mounted with the optional Extron SMA-1 swivel mount adapter, which allows them to be mounted permanently and swivel up to 180° in either direction.

1. Remove the back cover and base cover (see [Removing the Back and Base Covers](#) on the previous page).
2. Attach the conduit, insulation disk, and swivel disk and configure the set screws to allow for the degree of swivel that is required (see the *SMA-1 Swivel Mount Adapter Kit User Guide*, at www.extron.com).
3. Place the mounting hole in the base over the conduit of the SMA-1.
4. Secure the unit with the backing plate and locking nut as described in the *SMA-1 Swivel Mount Adapter Kit User Guide*.

VESA Mounting

The TLP Pro 1220TG, 1520TG, and 1720TG touch panels have VESA FDMI Type D 100 mm mounting patterns that can be used for VESA mounting with an appropriate third-party mounting kit.

Before VESA mounting, the base of the touchpanel must be removed.

1. Remove the back cover and base cover (see [Removing the Back and Base Covers](#) on the previous page).
2. If necessary, remove cables from the raceway in the base (see [figure 5](#) on page 12).
3. Remove the cables routed through the base. If necessary, cut the plastic ties that bundle the cables together.
4. Remove the screws holding the hinges to the touchpanel (see [figure 3](#), **M** on page 8).

NOTE: The spanner drive screws holding the hinges require a #6 spanner bit or #6 spanner head screwdriver (not provided).

5. Lift the TLP away from the base.
6. Follow the instructions provided with the VESA mounting kit.

Reference Material

This section describes:

- [Network Port Requirements and Licensed Third-Party Software Used by the Touchpanels](#)
- [Reset Modes](#)

Network Port Requirements and Licensed Third-Party Software Used by the Touchpanels

For information about network port requirements and licensed third-party software for the TLP Pro 1220, 1520, and 1720 series touchpanels, see the *Pro Series Control Product Network Ports and Licenses Guide*, which is available at www.extron.com.

Reset Modes

The TLP Pro 1220, 1520, and 1720 Series touchpanels have three reset modes that are initiated by pressing the **Reset** button:

- [Use Factory Firmware](#)
- [Reset All IP Settings](#)
- [Reset to Factory Defaults](#)

The **Reset** button is found on the rear panel (see [figure 3](#) on page 8).

Use Factory Firmware

This mode is used to boot up the unit with factory-installed firmware for a single power cycle in the event of a firmware update that failed or incompatibility issues arising with user-loaded firmware.

Activation

1. On the touchpanel, hold down the recessed **Reset** button while applying power to the unit. When power is restored, the Reset LED lights. Hold the **Reset** button for a further two seconds before releasing it. The touchpanel enters factory firmware mode.
2. Upload new firmware to the unit as desired (see [Updating the Firmware](#) on page 23).

NOTE: Do not continue to operate the touchpanel using the factory firmware version. If you want to use the factory default firmware, you must upload that version again (see [Updating the Firmware](#) on page 23).

Result

The unit reverts to factory-installed firmware. Event scripting does not start if the unit is powered on in this mode. All user files and settings such as drivers, adjustments, and IP settings are maintained.

NOTE: To return the unit to the firmware version that was running prior to the reset, cycle power to the unit.

Reset All IP Settings

This mode resets all IP settings to factory defaults.

Activation

To reset all IP settings:

1. Hold down the **Reset** button until the Reset LED blinks twice (once at 3 seconds and again at 6 seconds).
2. Release and press **Reset** momentarily (for <1 second) within 1 second. Nothing happens if the momentary press does not occur within 1 second.

Result

Reset All IP Settings mode:

- Sets the IP address back to factory default (192 . 168 . 254 . 251).
- Sets the subnet back to factory default (255 . 255 . 255 . 0).
- Sets the default gateway address to the factory default (0 . 0 . 0 . 0).
- Sets all other IP settings, addresses, and domain and host names back to factory default.
- Turns DHCP off.

Reset to Factory Defaults

This mode resets all IP settings and touchpanel settings to factory defaults and removes all configurations. It allows you to start over with configuration and uploading.

Activation

To reset the unit to all factory default settings:

1. Hold down the **Reset** button until the Reset LED blinks three times (once at 3 seconds, again at 6 seconds, and again at 9 seconds).
2. Release and press **Reset** momentarily (for <1 second) within 1 second. Nothing happens if the momentary press does not occur within 1 second.

Result

Reset to Factory Defaults mode performs a complete reset to factory defaults (except the firmware).

- Does everything Reset All IP Settings mode does.
- Removes touchpanel user interface layout and configurations.
- Resets all touchpanel settings to factory default.

Extron Warranty

Extron Electronics warrants this product against defects in materials and workmanship for a period of three years from the date of purchase. In the event of malfunction during the warranty period attributable directly to faulty workmanship and/or materials, Extron Electronics will, at its option, repair or replace said products or components, to whatever extent it shall deem necessary to restore said product to proper operating condition, provided that it is returned within the warranty period, with proof of purchase and description of malfunction to:

USA, Canada, South America, and Central America:

Extron Electronics
1230 South Lewis Street
Anaheim, CA 92805
U.S.A.

Japan:

Extron Electronics, Japan
Kyodo Building, 16 Ichibancho
Chiyoda-ku, Tokyo 102-0082
Japan

Europe and Africa:

Extron Europe
Hanzeboulevard 10
3825 PH Amersfoort
The Netherlands

China:

Extron China
686 Ronghua Road
Songjiang District
Shanghai 201611
China

Asia:

Extron Electronics Asia Pte. Ltd.
135 Joo Seng Road, #04-01
PM Industrial Bldg.
Singapore 368363
Singapore

Middle East:

Extron Middle East
Dubai Airport Free Zone
F13, PO Box 293666
Dubai, United Arab Emirates

This Limited Warranty does not apply if the fault has been caused by misuse, improper handling care, electrical or mechanical abuse, abnormal operating conditions, or if modifications were made to the product that were not authorized by Extron.

NOTE: If a product is defective, please call Extron and ask for an Application Engineer to receive an RA (Return Authorization) number. This will begin the repair process.

USA: 714.491.1500 or 800.633.9876

Europe: 31.33.453.4040

Asia: 65.6383.4400

Japan: 81.3.3511.7655

Units must be returned insured, with shipping charges prepaid. If not insured, you assume the risk of loss or damage during shipment. Returned units must include the serial number and a description of the problem, as well as the name of the person to contact in case there are any questions.

Extron Electronics makes no further warranties either expressed or implied with respect to the product and its quality, performance, merchantability, or fitness for any particular use. In no event will Extron Electronics be liable for direct, indirect, or consequential damages resulting from any defect in this product even if Extron Electronics has been advised of such damage.

Please note that laws vary from state to state and country to country, and that some provisions of this warranty may not apply to you.

| | | | | | | | |
|---|---|--|---|---|---|---|--|
| Extron Headquarters +1.800.633.9876 (Inside USA/Canada Only) Extron USA - West +1.714.491.1500 +1.714.491.1517 FAX | Extron Europe +800.3987.6673 (Inside Europe Only) Extron USA - East +1.919.850.1000 +1.919.850.1001 FAX | Extron Asia +65.6383.4400 +65.6383.4664 FAX | Extron Japan +81.3.3511.7655 +81.3.3511.7656 FAX | Extron China +86.21.3760.1568 +86.21.3760.1566 FAX | Extron Middle East +971.4.299.1800 +971.4.299.1880 FAX | Extron Australia +61.8.8351.2188 +61.8.8351.2511 FAX | Extron India 1800.3070.3777 (Inside India Only) +91.80.3055.3777 +91.80.3055.3737 FAX |
|---|---|--|---|---|---|---|--|