



User's Guide

Accent Lighting Laser Projector

EV-100



EV-105

Notations Used in This Guide





- **Safety indications**

The documentation and the projector use graphical symbols to show how to use the projector safely.

The indications and their meaning are as follows. Make sure you understand them properly before reading the guide.

 Warning	This symbol indicates information that, if ignored, could possibly result in personal injury or even death due to incorrect handling.
 Caution	This symbol indicates information that, if ignored, could possibly result in personal injury or physical damage due to incorrect handling.

- **General information indications**

Attention	Indicates procedures which may result in damage or injury if sufficient care is not taken.
	Indicates additional information and points which may be useful to know regarding a topic.
	Indicates a page where detailed information regarding a topic can be found.
	Indicates that an explanation of the underlined word or words in front of this symbol appears in the glossary of terms. See the "Glossary" section of the "Appendix".  "Glossary" p.164
[Name]	Indicates the name of the buttons on the remote control. Example: [Esc] button
Menu Name	Indicates Configuration menu items. Example: Select Brightness from Image . Image - Brightness

Make sure you read the following before you use the projector.

☛ [Safety Instructions](#)

Warning and Cautions on Installation

Use the mount supplied to install the projector on a wall or suspend it from a ceiling.

Optional mounts are necessary to install the projector on lighting tracks or to install it on the floor or a table.

☛ "List of Optional Accessories" [p.154](#)

Warning

- Do not use or install the projector where it may be subject to water or rain, or high humidity, such as outdoors, in a bathroom, or shower room, and so on. Otherwise, it could cause a fire or electric shock.
- A special method of installation is required when suspending the projector from a ceiling or mounting it on a wall. If installation work is not carried out correctly, the projector could fall down. This may result in injury or accidents. Make sure you contact a professional.
- If you use adhesives on the mount fixing points to prevent the screws from loosening, or if you use things such as lubricants or oils on the projector, the projector case may crack causing it to fall from its mount. This could cause an accident or injury to anyone under the mount.
Do not use adhesives, lubricants, oils, or similar substances to loosen the screws when adjusting the installation mount.
- If you use adhesives to prevent the screws from loosening, or use lubricants, oils, or similar substances on the ball joint, the strength holding the image projection unit in place decreases which could cause an accident or injury to occur.
- When installing the projector in a high position, take measures to prevent falling by using wires to ensure safety in an emergency, such as an earthquake, and to prevent accidents. If it is not installed correctly, it could fall causing an accident and injury.
- Do not cover the projector's air intake vent or air exhaust vent. If either of the vents is covered, the internal temperature could rise and cause a fire.
- Do not place flammable objects in front of the lens. If you set the schedule to turn on the projector automatically, any flammable objects placed in front of the lens could cause a fire.

Warning

- When adjusting the orientation of the image projection unit, make sure that the projected light does not fall on the projector's power supply section. If projected light falls on the projector, it may become hot causing an injury or fire to occur.
- Do not tie the power cord and other connection cables together. Otherwise, it could cause a fire.
- Only use the specified power-supply voltage. Otherwise, it could cause a fire or electric shock.
- Be careful when handling the power cord. Otherwise, it could cause a fire or electric shock. Note the following when handling the power cord.
 - Do not plug multiple power cords in a single electric outlet.
 - Do not plug in the power cord if there are any foreign substances, such as dust, stuck to it.
 - Make sure you insert the power cord all the way in.
 - Do not plug in or unplug the power cord with wet hands.
 - Do not pull the cord when unplugging the power cord. Make sure you hold it by the plug.
- Do not use a damaged power cord. Otherwise, it could cause a fire or electric shock. Note the following when handling the power cord.
 - Do not alter the power cord.
 - Do not place any heavy objects on the power cord.
 - Do not bend, twist, or pull the power cord forcibly.
 - Do not layout the power cord near a heating device.

Caution

Do not place the projector on an unstable surface, such as on an unstable table or tilted surface. Otherwise it may cause an injury. Make sure you install the optional Floor Stand when placing the projector on the floor and so on.

Attention

- Do not install the projector in a location that is subject to vibration or shock.
- Do not install the projector near a high-voltage line or object that generates magnetism. Otherwise, the projector may not work correctly.
- Do not use or store the projector in a location that is subject to extreme temperatures. Also, avoid sudden temperature changes. Make sure you use or store the projector in a place that is within the following operating or storage temperature ranges.
 - Operating temperature range
+5 to +40°C (No condensation)
 - Storage temperature
-10 to +60°C (No condensation)
- When using at an altitude that exceeds 1,500 m, set **High Altitude Mode** to **On**.
 **Extended - Operation - High Altitude Mode** p.99
- Make sure you secure the following space around the projector so as not to block the Air intake vent and the Air exhaust vent. Do not install the projector in a location that does not allow air to circulate, such as on a shelf or in a box.
- When installing the projector on a ceiling or wall, make sure it is not close to the air exhaust vent of an air conditioner.

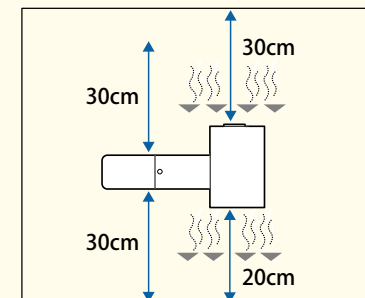

Attention

- Try not to setup the projector in locations subject to high humidity and dust, or in locations subject to smoke from fires or tobacco smoke.
- When setting up multiple projectors, make sure there is a gap of at least 50 cm between the projectors. Also, make sure that the heat from the air exhaust vent does not go into the air intake vent.

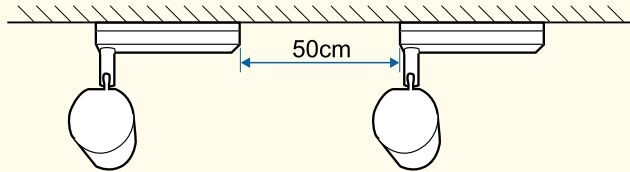

- The cable connecting the power supply unit and the image projection unit is wrapped in plastics at the time of purchase. Make sure you remove the plastics before using the projector.



We recommend setting the focus, zoom, and lens shift at least 20 minutes after you start the projection, because images are not stable right after turning on the projector.

Warning and Cautions on Usage

Warning

- Do not cover the projector's air intake vent or air exhaust vent. If either of the vents is covered, the internal temperature could rise and cause a fire.
- Do not look into the lens while projecting. The powerful light emitted could cause damage to eyesight. Take particular care when there are children present. When turning on the projector at a distance using the remote control, make sure there is no one looking into the lens.

- During projection, do not block the light from the projector with a book and so on.

If the light from the projector is blocked, the area on which the light shines becomes hot which could cause it to melt, burn, or start a fire. Also, the lens may get hot due to the reflected light which could cause the projector to malfunction. To stop projection, use the A/V Mute function, or turn off the projector.

- Do not open the projector's case. Never disassemble or remodel the projector. There are high-voltage components inside the projector that could cause fire, electric shock, or an accident.
- If an error occurs, disconnect the power cord from the electrical outlet, and contact your local dealer or the nearest address provided in the Epson Projector Contact List. If you continue using the projector as it is, it could cause an electric shock, fire, or even damage to eyesight.

 [Epson Projector Contact List](#)

Caution

Do not place objects that may become warped or otherwise affected by heat near the air exhaust vent and do not put your face or hands near the vent while projection is in progress.

Attention

- Try not to touch the lens section with your hand or fingers. If fingerprints or oils are left on the surface of the lens, projection quality deteriorates.
- When storing, make sure you remove the batteries from the remote control. If the batteries are left in the remote control for an extended period of time, they may leak.



- About the LCD panel

- The LCD panel may contain pixels that are missing or appear bright all the time. This is not a sign of an error.
- When a high-powered laser beams through the surface of the projection lens even when it is not being used, it can cause a malfunction in the LCD panel.
- If the same image is projected for an extended period, burning may occur on the LCD panel. Use **Refresh Mode** to reduce burning.
 - ☛ "Refresh Mode" [p.139](#)

- About the light source

The projector uses a laser as the light source. The laser has the following characteristics.

- Depending on the surroundings, the output of the light source may be reduced. The output is reduced a lot when the temperature gets too high.
- The output of the light source is reduced the longer it is used. You can change the relationship between usage time and reduction in output in **Brightness Settings**.
 - ☛ "Setting the Brightness" [p.52](#)



- Light Source Calibration

- Whenever the usage time reaches 100 hours, Light Source Calibration starts automatically when the projector is turned off. However, this does not start automatically when the projector is used continuously for more than 24 hours, or when direct shutdown is used regularly. Execute with **Run Now**, or set **Light Source Calibration** using the scheduling function to adjust the light source periodically.
 - ☛ **Reset - Light Source Calibration** [p.113](#)
 - ☛ "Setting an Event Schedule" [p.71](#)
- If you do not want to start Light Source Calibration automatically, set **Run Periodically** to **Off**.
 - ☛ **Reset - Light Source Calibration - Run Periodically** [p.113](#)
- Execute Light Source Calibration to correct the white balance in the light source.

Warning and Cautions on the Laser

Warning

- Laser warning labels are attached inside the projector and on the side of the projector.

Inside

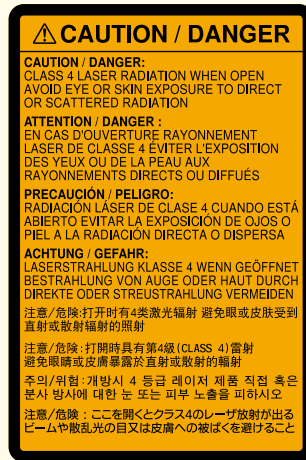

Warning

Side

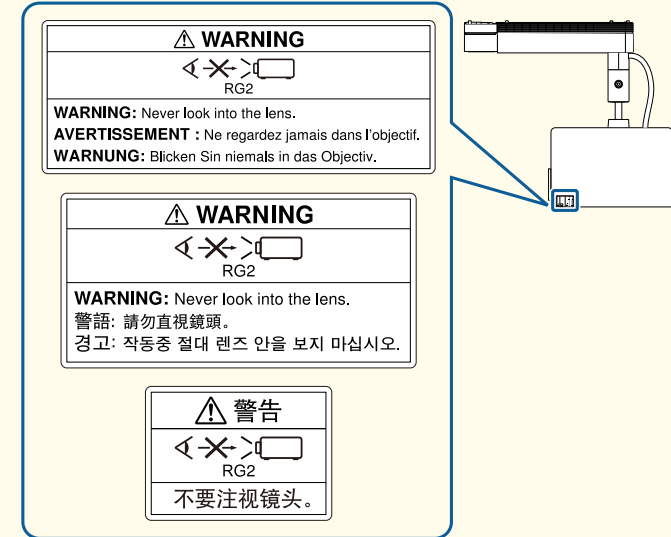

Warning

- Do not open the projector's case. The projector contains a high-powered laser.
- Do not look into the light emitted from the projection lens while projecting. (Based on the RG2 IEC/EN 62471-5: 2015)

Caution

- This projector is a Class 1 laser product that complies with the IEC/EN60825-1: 2014 international standard for lasers.
- Do not disassemble the projector when disposing of it. Dispose according to your local or national laws and regulations.

Notes on Transporting

There are many glass parts and precision components inside the projector. To prevent damage due to impacts when transporting, handle the projector as follows.

Attention

- To move it closer, turn off the projector and unplug all of the wires.
- When Transporting
As well as the precautions above, prepare the following and contact your courier.
 - Make sure there is no SD card inserted in the projector.
 - Tighten the ball joint fixing screw completely to prevent the projector from moving during transportation.
 - Protect the outside of the projector so that it does not receive any impacts during transportation.
 - Place the projector in a sturdy box and indicate on the box that it is a precision instrument.

Notations Used in This Guide 2

Introduction

Part Names and Functions 14

Front	14
Rear	15
Interface	16
Top	17
Remote Control	18

Preparing the Projector

Projector Placement 21

Types of Installation	21
Adjust the projection angle using the ball joint	22

Connecting to Various Devices 24

Setting Up the Remote Control 26

Inserting Batteries into the Remote Control	26
Remote control operating range	27

Default Projector Settings 28

Setting the Image Orientation (Projection)	28
Changing the Projection Mode Using the Remote Control	28
Changing the Projection Mode Using the Menus	28
Selecting the Language for the Projector Menus	29
Setting the Date and Time	30
Other Settings	31
Settings related to basic operations	31
Settings related to display	31

Basic Usage

Turning On/Off the Projector 34

Turning On the Projector	34
Turning Off the Projector	35

Switching to the Target Image by Remote Control 36

Using Spotlight 37

Playing a Playlist 38

Playing a Playlist on an SD Card	38
Playing Your Favorite Playlist	38
Selecting and Playing a Playlist	39

Operating the Projector Using a Mobile Device or Computer

..... 40

Operating Using Epson iProjection (iOS/Android)	40
Operating Using Epson Web Control (Web Browser)	40
Viewing Each Screen	42
Remote screen	42
Playlists screen	42
SD Card screen	43
Time Table screen	43
OSD Control Pad screen (Epson Web Control only)	44

Using Overlay Effect 45

Setting the Shape of the Effect	45
Adjusting the Color of the Effect	46
Adjusting the Brightness of the Overlay Effect	47

Adjusting the projected images 48

Displaying a Test Pattern	48
Adjusting the Image Size	49
Correcting the Focus	49
Correcting Distortion in the Projected Image	49
Correcting H/V-Keystone	50
Quick Corner	51
Selecting the Projection Quality (Selecting Color Mode)	52

Setting the Brightness 52
 Setting the Amount of Light of the Projected Image 54
 Changing the Aspect Ratio of the Projected Image 54
 Adjusting the Gamma Value of the Projected Image 55

Adjusting the Volume 57

Hiding the Image and Sound Temporarily (A/V Mute) 58

Useful Functions

Projecting One Image from Multiple Projectors (Multi-Projection) 60

Adjustment Procedure 60
 Advance preparation 60
 Adjusting the projected images 60
 Setting the Projector ID 61
 Set the projector ID 61
 Adjusting the Points Where the Images Overlap (Edge Blending) 62
 Displaying a Scaled Image 64
 Adjusting Multiple Projected Images 65
 Adjusting uneven colors (Color Uniformity) 65
 Adjusting the tint (Color Matching) 67

Playing the Same Image Simultaneously on Multiple Projectors (Synchronized Playback) 69

Starting Synchronized Playback 69

Saving a User's Logo 70

Setting an Event Schedule 71

Managing Users (Password Protection) 73

Kinds of Password Protection 73
 Setting a Password 73
 Selecting Password Security Types 74
 Entering a Password to Use the Projector 74

Using the Projector on a Network

Wired Network Projection 77

Selecting Wired LAN Settings 77

Wireless Network Projection 80

Selecting Wireless Network Settings Manually 81
 Selecting Wireless Network Settings in Windows 83
 Selecting Wireless Network Settings in Mac 83
 Setting Up Wireless Network Security 84
 Supported Client and CA Certificates 86
 Using a QR Code to Connect a Mobile Device 86

Secure HTTP 88

Importing a Web Server Certificate Using the Menus 88
 Supported Web Server Certificates 89
 Setting a certificate using a Web browser 89

Configuration Menu

Using the Configuration Menu 92

List of Functions 94

Configuration Menu Table 94
 Network menu 95
 Image Menu 96
 Signal Menu 97
 Settings Menu 98
 Extended Menu 99
 Network Menu 102
 Notes on operating the Network menu 103
 Soft keyboard operations 103
 Basic menu 104
 Wireless LAN menu 105
 Wired LAN menu 108
 Notifications Menu 109
 Others menu 110

Reset menu	111
Info Menu (Display Only)	112
Reset Menu	113
Batch Setup	114
Making Settings Using an SD Card	114
Saving settings to an SD card	114
Reflecting saved settings to other projectors	116
When Setup Fails	117

Troubleshooting

Reading the Indicators	119
Problem Solving	124
Problems Relating to Images	125
No images appear	125
Moving images are not displayed	125
The playlist does not play.	126
Not supported is displayed	126
No Signal is displayed	126
Images are fuzzy, out of focus, or distorted	127
Interference or distortion appear in images	127
The image is truncated (large) or small, the aspect is not suitable, or the image has been reversed	127
Image colors are not right	128
Images appear dark	129
Burning appears on the LCD panel.	129
Problems when Projection Starts	129
The projector does not turn on	129
Solving Network Problems	130
Solutions When Wireless Authentication Fails	130
Solutions When You Cannot Access the Projector using a Web browser	130
Cannot operate the SD card using a Web browser (save/delete playlist, upload data).	131
Email is not received even if a problem occurs in the projector	131
Solutions When the Image Contains Static During Network Projection	131
Other Problems	132

No sound can be heard or the sound is faint	132
The remote control does not work	132
I want to change the language for messages and menus	133
Solutions to Password Problems	133
The battery that saves your clock settings is running low. is displayed	133
Detailed logs and error message are not displayed	133
Cannot control Art-Net correctly.	134

About Event ID	135
-----------------------	------------

Maintenance

Cleaning	138
Cleaning the Projector's Surface	138
Cleaning the Lens	138
Cleaning the Air Intake Vent and the Air Exhaust Vent	138
Image Maintenance	139
Color Uniformity	139
Refresh Mode	139
Light Source Calibration	140

Appendix

Monitoring and Controlling	142
Epson Projector Management	142
Using the Mail Notification Function to Report Problems	142
Reading error notification mail	142
Management Using SNMP	143
ESC/VP21 Commands	143
Command list	143
About PJLink	143
About Crestron Connected®	144
Operating a projector from your computer	144
Art-Net	149
Channel definitions	149



Web API	153
List of Optional Accessories	154
Screen Size and Projection Distance	155
Supported Monitor Displays	157
Specifications	160
Projector General Specifications	160
Appearance	163
Glossary	164
General Notes	165
Trademarks and Copyrights	165
List of Safety Symbols	167
Index	169



Introduction

This chapter explains the names for each part.

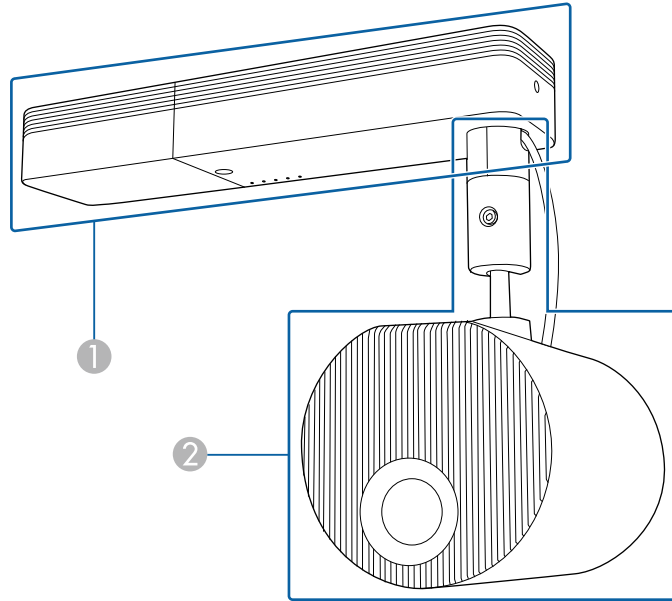

The following sections explain the projector parts and their functions.

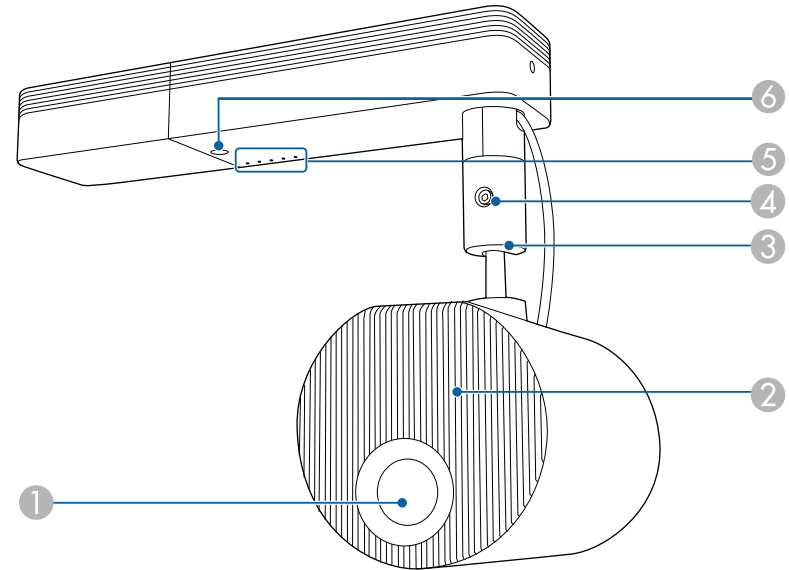

- ① Power unit
- ② Image projection unit

Front



Name	Function
① Projection lens	Images are projected through here. <div style="border: 1px solid black; padding: 5px; margin-top: 10px;"> Warning Do not look into the lens while projecting. This could cause damage to eyesight due to the powerful light emitted.</div>
② Air intake vent	Takes in air to cool the projector internally.  "Cleaning the Air Intake Vent and the Air Exhaust Vent" p.138
③ Ball joint	Use this to change the projection angle.  "Adjust the projection angle using the ball joint" p.22
④ Ball joint fixing screw	Screw to secure the ball joint in place.

Name	Function
5 Indicators	Displays the projector's status. ☞ "Reading the Indicators" p.119
6 Remote receiver	Receives signals from the remote control.

Rear

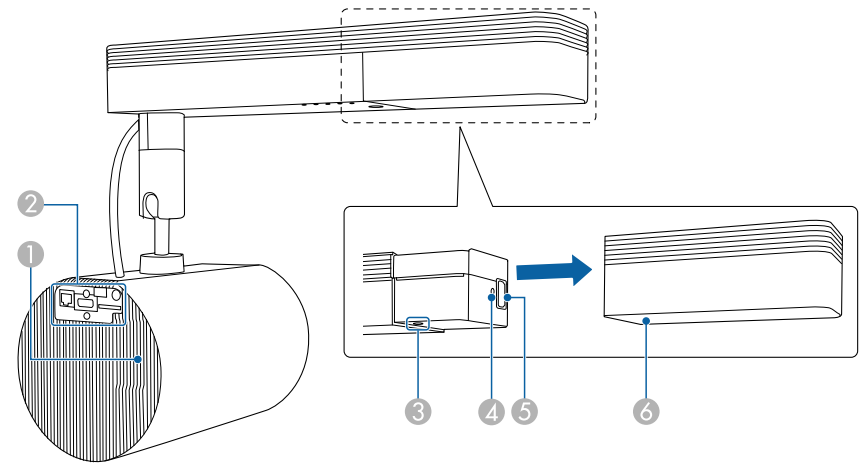

Name	Function
1 Air exhaust vent	Exhaust vent for air used to cool the projector internally. <div style="border: 1px solid black; padding: 5px; background-color: #ffffcc;"> <p>⚠ Caution</p> <p>While projecting, do not put your face or hands near the air exhaust vent, and do not place objects that may become warped or damaged by heat near the air exhaust vent. Hot air from the air exhaust vent could cause burns, warping, or accidents to occur.</p> </div> <p>☞ "Cleaning the Air Intake Vent and the Air Exhaust Vent" p.138</p>
2 Interface	☞ "Interface" p.16
3 [⏻] button	Turns the projector on or off.

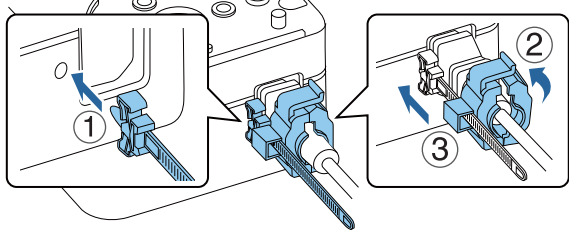
Name	Function
④ Cable holder	Insert the cable clamp so that the power cord does not disconnect under its own weight. 
⑤ Power inlet	Connects the power cord to the projector.
⑥ Power adapter cover	The cover for the power port and the power button.

Interface

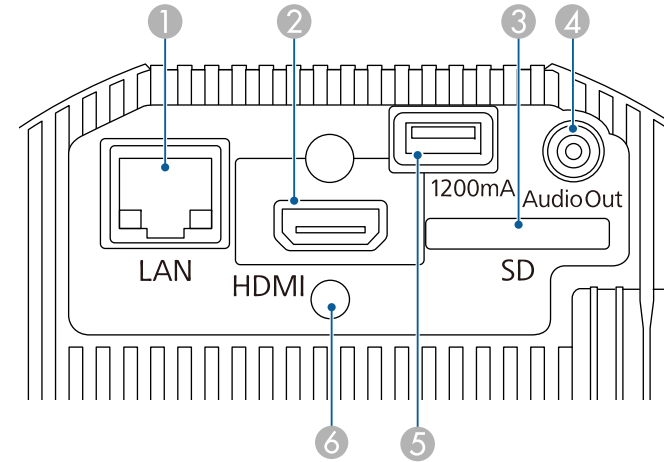



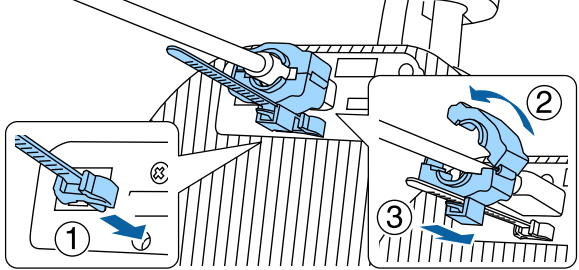

Name	Function
① LAN port	Connects a LAN cable to connect to a network. Supports Art-Net.  "Art-Net" p.149
② HDMI port	Inputs video signals from HDMI compatible video equipment and computers.
③ SD card slot	Insert an SD card into this slot.
④ Audio Out port	Outputs audio from the currently projected image to an external speaker.
⑤ USB-A port (dedicated power supply/1,200 mA)	Connects and supplies power to a USB cable. This cannot be used to transfer data.

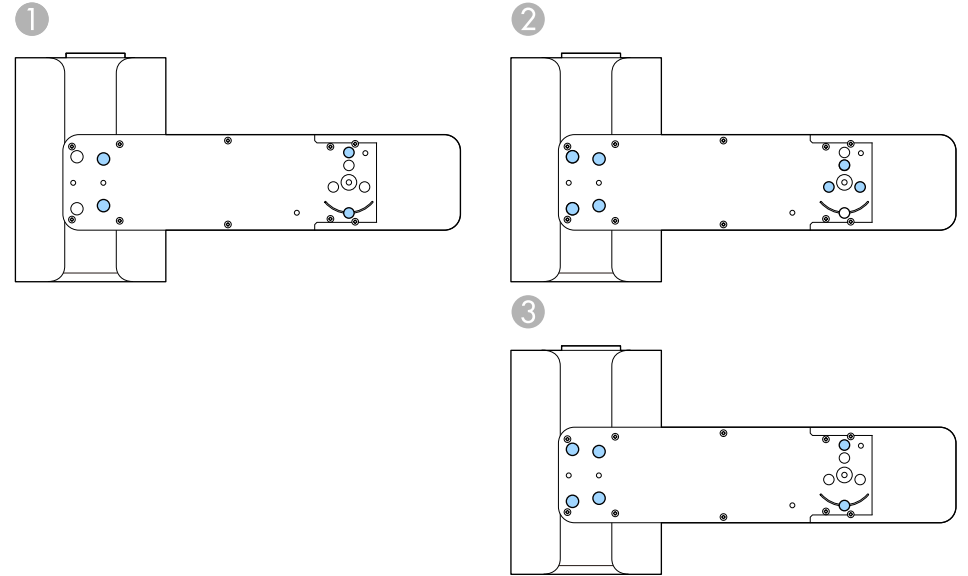
Name	Function
<p>6 Cable holder</p>	<p>Insert the cable clamp so that the HDMI cord does not disconnect under its own weight.</p> 

Top







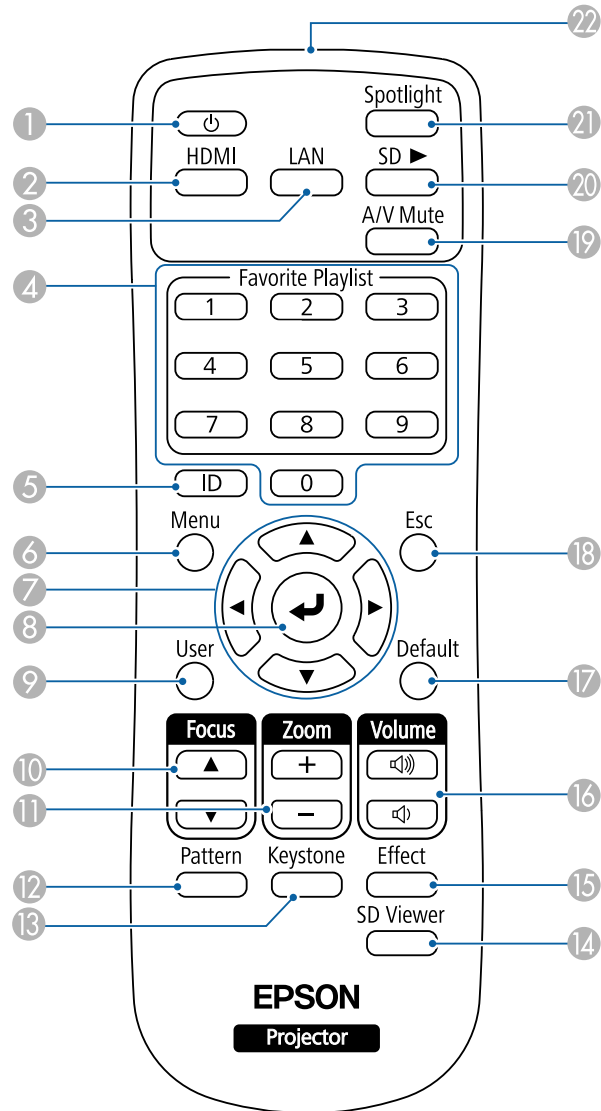



Name	Function
<p>1 Direct Mount fixing points (four points)</p>	<p>Install the Direct Mount when suspending the projector from a ceiling or mounting on a wall.  "Projector Placement" p.21</p>
<p>2 Lighting Track Mount fixing points (seven points)</p>	<p>Install the optional Lighting Track Mount when installing the projector on a lighting track.  "Projector Placement" p.21  "List of Optional Accessories" p.154</p>
<p>3 Floor Stand fixing points (six points)</p>	<p>Install the optional Floor Stand when placing the projector on the floor.  "Projector Placement" p.21  "List of Optional Accessories" p.154</p>

Remote Control



Name	Function
① [⏻] button	Turns the projector on or off.
② [HDMI] button	Changes to images from the HDMI input port.
③ [LAN] button	Switches the image source between the network connected devices.
④ Numeric buttons	<ul style="list-style-type: none"> Plays your favorite playlist (1 to 9 only). <ul style="list-style-type: none"> "Playing Your Favorite Playlist" p.38 Enter the Password. <ul style="list-style-type: none"> "Managing Users (Password Protection)" p.73
⑤ [ID] button	Hold down this button and press the numeric buttons to select the ID for the projector you want to operate using the remote control. <ul style="list-style-type: none"> "Setting the Projector ID" p.61
⑥ [Menu] button	Displays and closes the Configuration menu. <ul style="list-style-type: none"> "Using the Configuration Menu" p.92
⑦ [▲][▼][◀][▶] buttons	When the Configuration menu is displayed, pressing these buttons selects menu items and setting values. <ul style="list-style-type: none"> "Using the Configuration Menu" p.92
⑧ [↵] button	When the Configuration menu is displayed, it accepts and enters the current selection and moves to the next level. <ul style="list-style-type: none"> "Using the Configuration Menu" p.92
⑨ [User] button	Performs settings assigned in the User Button setting in the projector's Configuration menu. <ul style="list-style-type: none"> "Settings Menu" p.98
⑩ [Focus] button	Press to adjust the focus. <ul style="list-style-type: none"> "Correcting the Focus" p.49
⑪ [Zoom] button	Press to adjust the zoom. <ul style="list-style-type: none"> "Adjusting the Image Size" p.49
⑫ [Pattern] button	Displays a test pattern. <ul style="list-style-type: none"> "Displaying a Test Pattern" p.48

	Name	Function
13	[Keystone] button	Corrects distortion in the projected image.  "Correcting Distortion in the Projected Image" p.49
14	[SD Viewer] button	Displays the list of playlists.  "Playing a Playlist" p.38
15	[Effect] button	Use the Overlay Effect function to change the shape and color of the image.  "Using Overlay Effect" p.45
16	[Volume] buttons [<⏮][<⏪]	[<⏮] Increases the volume. [<⏪] Decreases the volume.  "Adjusting the Volume" p.57
17	[Default] button	Enabled when [Default]: Reset is displayed on the Configuration menu guide. The settings being adjusted are returned to their default values.  "Using the Configuration Menu" p.92
18	[Esc] button	<ul style="list-style-type: none"> • Stops the current function. • If pressed when the Configuration menu is displayed, it moves to the previous level.  "Using the Configuration Menu" p.92
19	[A/V Mute] button	Turns the video and audio on or off.  "Hiding the Image and Sound Temporarily (A/V Mute)" p.58
20	[SD ▶] button	Plays the playlist on the SD card.  "Playing a Playlist" p.38
21	[Spotlight] button	Switches to Spotlight mode.  "Using Spotlight" p.37
22	Remote control light-emitting area	Outputs remote control signals.



Preparing the Projector

Follow the instructions in these sections to set up your projector.

Types of Installation

You can install the projector in the following ways.

Suspending from a ceiling or mounting on a wall

- Use the Direct Mount supplied when suspending from a ceiling or installing on a wall.
- You need the optional Lighting Track Mount when installing on a lighting track.
- When suspending from a ceiling or installing on a wall, we recommend a horizontal ceiling or a vertical wall. See the Installation Manual for details.

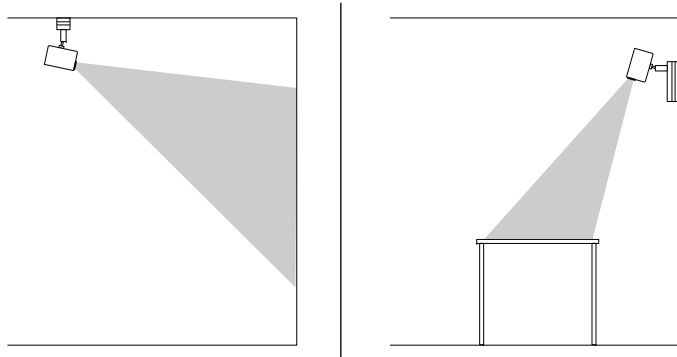

Installing on a floor or table

- You need the optional Floor Stand when installing on the floor or a table.
- Do not install on the floor or a table using the supplied Direct Mount.



Place the projector in a level and stable location.

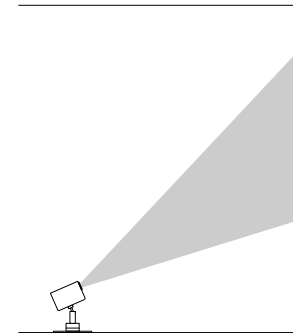

Make sure you select the correct **Projection** option in the projector's **Extended** menu according to the installation method being used.



- The default **Projection** setting is **Front/Ceiling**.
- You can change the **Projection** setting as follows by pressing down the [A/V Mute] button on the remote control for about five seconds.
Front/Ceiling, Rear, Rear/Ceiling, Front
- Install the projector within the recommended projection range.
☛ "Screen Size and Projection Distance" p.155
- You can rotate the ball joint 360° horizontally and 90° vertically. You can also tilt the image 90° to the portrait orientation.

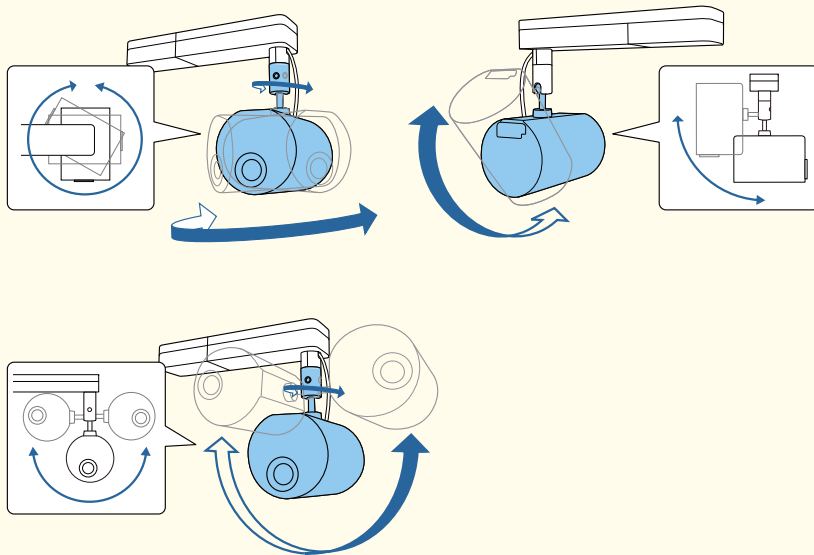

☛ "Setting the Image Orientation (Projection)" p.28

Adjust the projection angle using the ball joint

Adjust using the ball joint to change the projection angle.

- 1** Press the [⏻] button on the remote control to turn on the projector.
☛ "Turning On the Projector" p.34
- 2** Loosen the ball joint fixing screw using a hexagonal wrench.

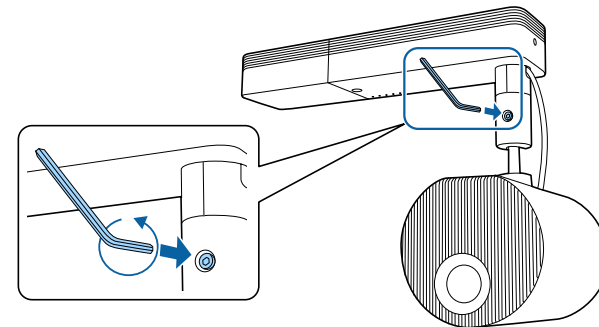

Attention

- If you loosen the screw while the image projection unit is tilted, the image projection unit may move suddenly under its own weight. When loosening the screw, make sure you support the projector's image projection unit so that the projector does not move suddenly.

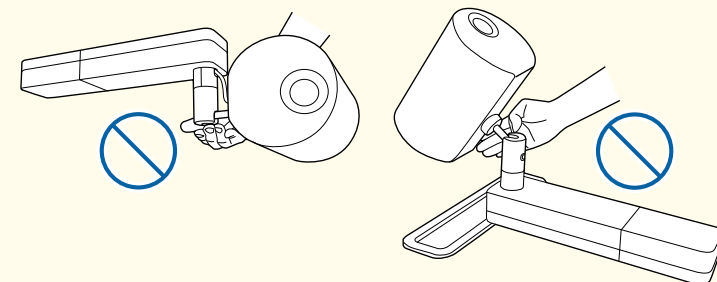

- Do not grip the ball joint when loosening the screw. Otherwise, your fingers could get trapped.

- 3** Adjust the projection angle.

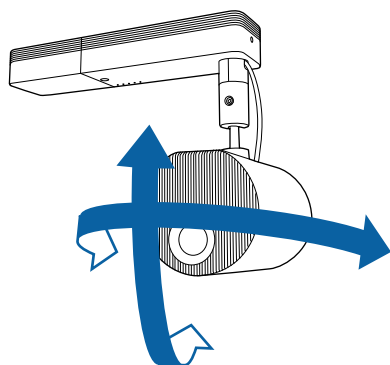

Attention

- Do not apply excessive force to the cables connected to the projector.
- Do not wind cables around the ball joint. Otherwise, the cables could be damaged.

- 4** After you finish making adjustments, tighten the ball joint fixing screw that you loosened.

Caution

- Make sure you do not trap your fingers in the ball joint.
- Do not force the ball joint to move after tightening the ball joint fixing screw.

Attention

Make sure you support the bottom of the image projection unit so that it does not move, and tighten the screw with the hexagonal wrench supplied (diagonal size 5.0 mm).



- Adjust the size and focus after changing the projection position.
 - ☛ "Adjusting the Image Size" [p.49](#)
 - ☛ "Correcting the Focus" [p.49](#)
- Displaying the test pattern makes it easier to adjust the projection position.
 - ☛ "Displaying a Test Pattern" [p.48](#)

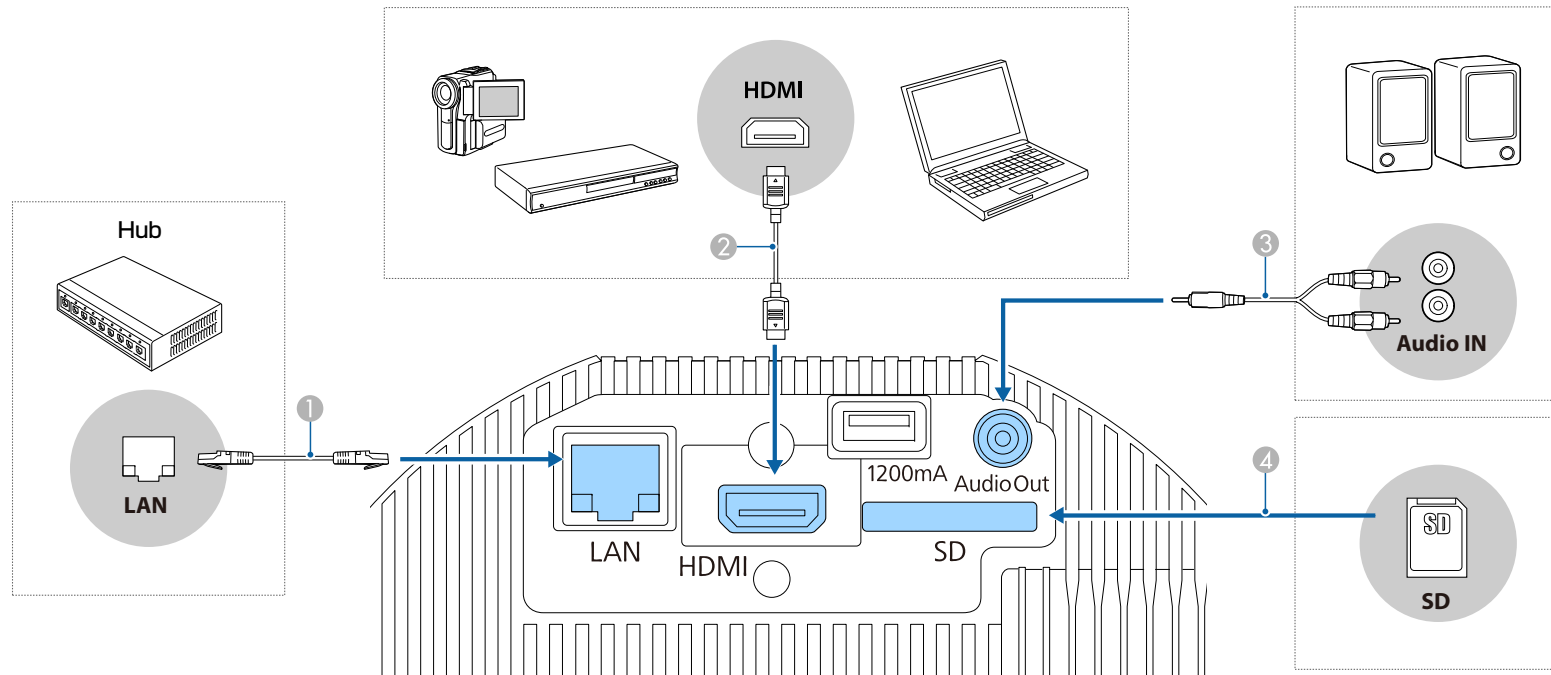

① When Connecting to a Wired Network

Connect a LAN port on network hubs or other equipment to the projector's LAN port with a commercially available 100BASE-TX or 10BASE-T LAN cable.



To prevent malfunctions, use a category 5 or higher shielded LAN cable.

② When Connecting to a Computer or Video Source

Connect the HDMI port on the computer or video source to the projector's HDMI port.

You can send the computer's or the video source's audio with the projected image.

③ When connecting to an external speaker

Connect the external speaker to the projector's Audio Out port using a commercially available audio cable.

Attention

Do not connect headphones or earphones to the projector. Excessive sound pressure may cause hearing loss.

4 When inserting an SD card

Insert a commercially available SD card into the projector's SD card slot.



- The projector supports SDHC cards of Class 10 or higher with a maximum of 32 GB.
- Make sure you use SD cards in FAT16 or FAT32 format.

Attention

- If the input source is on when you connect it to the projector, it could cause a malfunction.
- If the orientation or shape of the plug differs, do not try to force it in. The device could be damaged or could malfunction.



If the source you want to connect to has an unusually shaped port, use the cable supplied with the device or an optional cable to connect to the projector.

Inserting Batteries into the Remote Control

The remote control uses the two AA batteries that came with the projector.

Attention

Make sure you read the following manual before handling the batteries.

 [Safety Instructions](#)

- 1 Remove the battery cover.

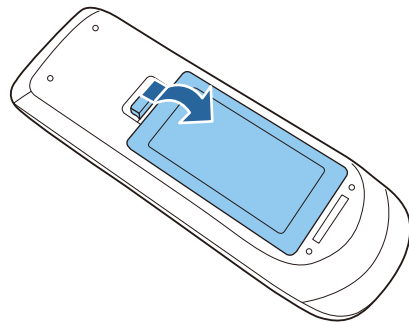

- 2 Insert the batteries with the + and - ends facing as shown.

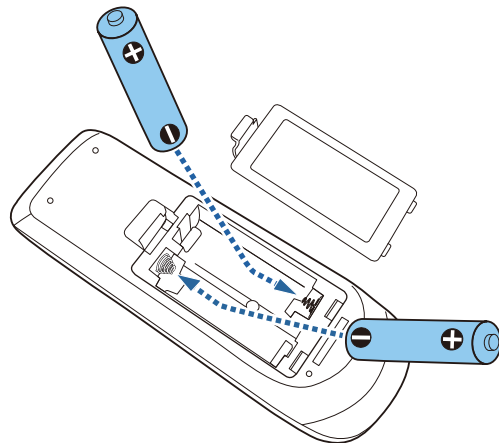

Caution

Check the positions of the (+) and (-) marks inside the battery holder to ensure the batteries are inserted the correct way.

If the batteries are not used correctly, they could explode or leak causing a fire, injury, or damage to the product.

- 3 Replace the battery cover and press it down until it clicks into place.

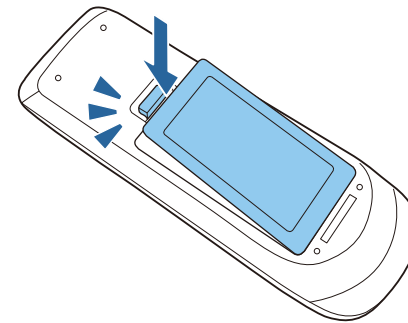

Remote control operating range

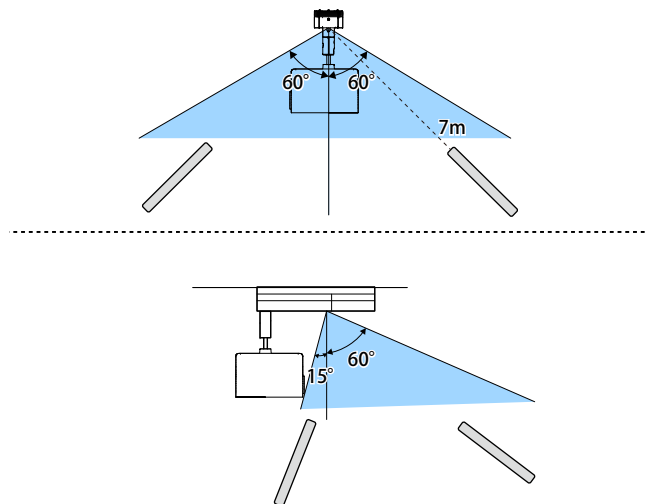

To restrict reception of the operation signals from the remote control, set **Remote Receiver**.

☛ **Settings - Remote Receiver** [p.98](#)

Setting the Image Orientation (Projection)

Depending on how you positioned the projector, you may need to change the projection mode so your images project correctly.

When the projector is suspended from a ceiling, the image directions for each projection mode are as follows.

Front/Ceiling (Default)



Rear/Ceiling



Rear



Front



Changing the Projection Mode Using the Remote Control

You can change the projection mode to flip the image over top-to-bottom.

- 1 Turn on the projector and display an image.
☛ "Turning On the Projector" [p.34](#)
- 2 Hold down the [A/V Mute] button on the remote control for 5 seconds.

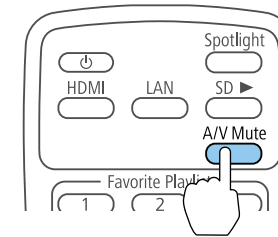

The image disappears briefly and reappears flipped top-to-bottom.

- 3 To change projection back to the original mode, hold down the [A/V Mute] button for 5 seconds again.

Changing the Projection Mode Using the Menus

You can change the projection mode to flip the image over top-to-bottom and/or left-to-right using the projector menus.

- 1 Turn on the projector and display an image.
☛ "Turning On the Projector" [p.34](#)
- 2 Press the [Menu] button on the remote control.

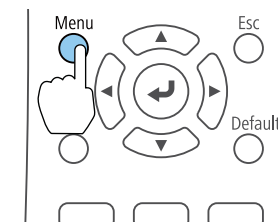

- 3 Select **Extended**, and then press the [

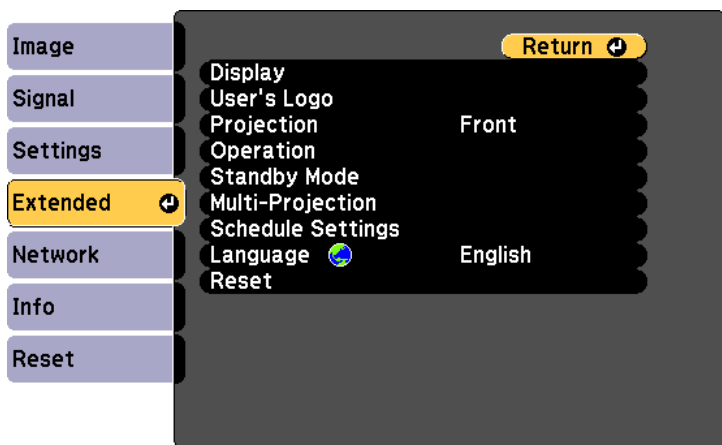

[Esc] / [Return]:Return [Left Arrow]:Select [Menu]:Exit

- 4 Select **Projection**, and then press the [Enter] button.

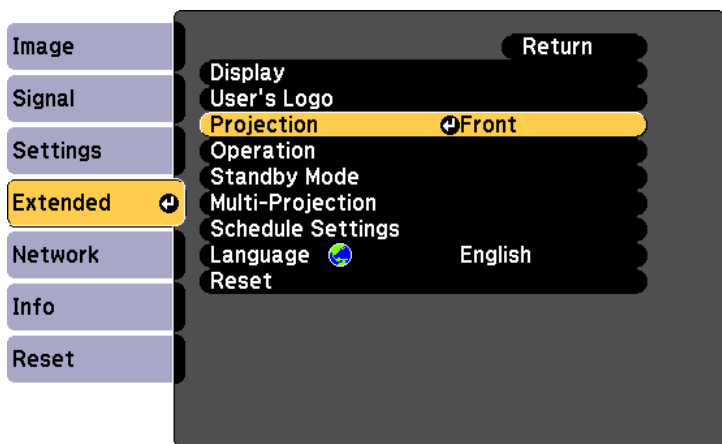

[Esc] :Return [Left Arrow]:Select [Enter]:Enter [Menu]:Exit

- 5 Select a projection mode, and then press the [Enter] button.

- 6 Press the [Menu] button or the [Esc] button to close the menu.

Selecting the Language for the Projector Menus

If you want to view the projector's menus and messages in another language, you can change the Language setting.

- 1 Turn on the projector and your computer.
 ➔ "Turning On the Projector" [p.34](#)
- 2 Press the [Menu] button on the remote control.

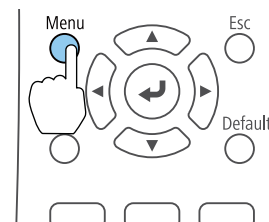

- 3 Select **Extended**, and then press the [Enter] button.

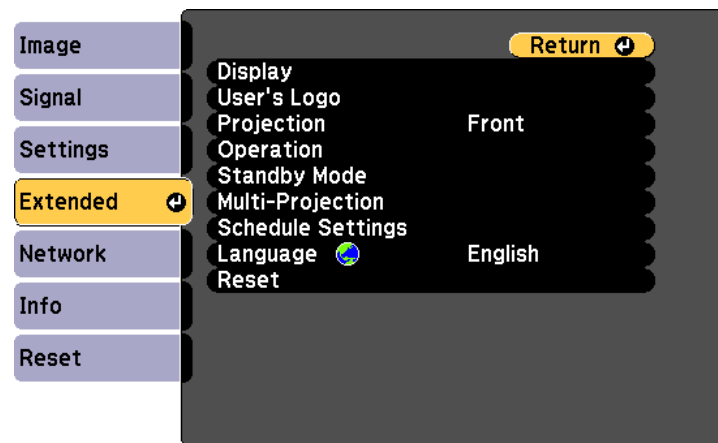

[Esc] / [Return]:Return [Left Arrow]:Select [Menu]:Exit

- 4** Select **Language**, and then press the [**↵**] button.
- 5** Select the language you want to use, and then press the [**↵**].
- 6** Press the [Menu] button or the [Esc] button to close the menu.

- 3** Select **Operation** from **Extended**.
- 4** Select **Date & Time**, and then press the [**↵**] button.
- 5** Make settings for the date and time.
Use the soft keyboard to enter the date and time.
☛ "Soft keyboard operations" [p.103](#)

Setting the Date and Time

You can set the date and time for the projector. The set date and time is used for the schedule function.

☛ "Setting an Event Schedule" [p.71](#)



- When you turn on the projector for the first time, the message "Do you want to set the time?" is displayed. When you select **Yes**, the screen from step 5 is displayed.
- When **Schedule Protection** is set to **On** in **Password Protection**, settings related to the date and time cannot be changed. You can make changes after setting **Schedule Protection** to **Off**.
☛ "Managing Users (Password Protection)" [p.73](#)

- 1** Turn on the projector.
☛ "Turning On/Off the Projector" [p.34](#)
- 2** Press the [Menu] button on the remote control.
☛ "Using the Configuration Menu" [p.92](#)

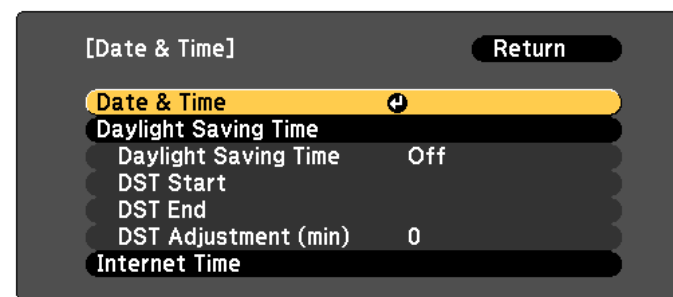
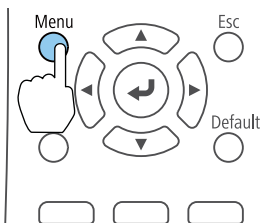

Date & Time

Submenu	Function
Date	Set today's date.
Time	Set the current time.
Time Difference (UTC)	Set the time difference from Coordinated Universal Time.
Set	The settings made in Date & Time are applied.

Daylight Saving Time

Submenu	Function
Daylight Saving Time	Set whether or not (On/Off) to activate the daylight saving time. DST Adjustment (min) adjusts the time difference between the standard time and daylight saving time.

Submenu	Function
DST Start	Set the date and time to start the daylight saving time.
DST End	Set the date and time to end the daylight saving time.
Set	The settings made in Daylight Saving Time are applied.

Internet Time

Submenu	Function
Internet Time	Set to On to update the time automatically through an Internet time server.
Internet Time Server	Input the IP address for an Internet time server.
Set	The settings made in Internet Time are applied.





When changing settings, make sure you select **Set**, and then press the [**↵**] button.



- 6 Press the [Menu] button to finish making settings.

Other Settings

Settings related to basic operations

Purpose	Setting Methods
To start/stop projection by turning on/off the main power or plugging in or unplugging the power plug of the projector.	Set Direct Power On to On . (Default value: Off)  Extended - Operation - Direct Power On p.99 The projector can be powered off directly by the breaker because it supports the direct shutdown function.
To operate the projector by communication command even when the power of the projector is off.	Set Standby Mode to Communication On . (Default value: Communication Off)  Extended - Standby Mode - Standby Mode p.99
Turn off the power by pressing the [⏻] button once.	Set Standby Confirmation to Off . (Default value: On)  Extended - Display - Standby Confirmation p.99

Settings related to display

Purpose	Setting Methods
To disable the display of the message on the projection screen when switching the source.	Set Messages to Off . (Default value: On)  Extended - Display - Messages p.99 You can check the warning settings by the way the indicators are displayed.  "Reading the Indicators" p.119 Dialogs related to operations and behaviors, laser warnings, termination of Message Broadcasting for Epson Projector Management, and projector ID are displayed.

Purpose	Setting Methods
To display the User's Logo when you turn on the projector.	Startup Screen: Set whether or not (On/Off) to display the user logo when the projector is turned on. (Default value: On) ☛ Extended - Display - Startup Screen p.99



Basic Usage

This chapter explains how to project and adjust images.

Turning On the Projector

Before turning on the projector, connect your computer or video equipment to the projector.

☛ "Connecting to Various Devices" p.24

- 1 Connect the projector to an electrical outlet with the power cord.

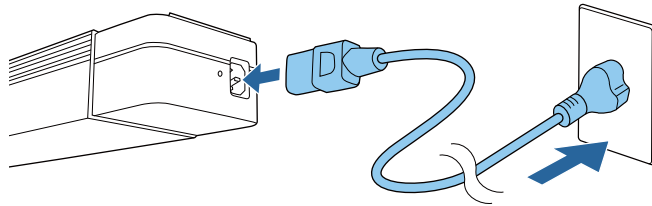

The projector's On/Standby indicator turns blue (it is in standby mode). This indicates that the projector is receiving power, but is not yet turned on.



When the projector is installed on a lighting track, the projector enters standby status when you turn on the power to the lighting track.

- 2 Press the [⏻] button on the projector or the [⏻] button on the remote control to turn on the projector.

The Status indicator flashes blue (warm-up state). Once the projector is warmed up, the Status indicator stops flashing and turns blue.

If the image is not projected, check the following.

- Turn on the connected computer or video equipment.
- When using a laptop computer, change the screen output of the computer.
- Insert media such as a DVD and play it back.
- Press the button for the input source that you want to project by using the remote control.

Warning

- Do not look into the projector's lens during projection. Doing so may damage your eyes. Be especially careful if children are present.
- During projection, do not block the light from the projector with a book and so on. If the light from the projector is blocked, the area on which the light shines becomes hot which could cause it to melt, burn, or start a fire. Also, the lens may get hot due to the reflected light which could cause the projector to malfunction. To stop projection, use the A/V Mute function or turn off the projector.



- If **Direct Power On** is set to **On** in the **Extended** menu, the projector automatically turns on when the power cord is connected to it. When the power cord is plugged in, note that the projector turns on automatically in cases such as recovery from a power outage.
 - ☛ **Extended - Operation - Direct Power On** p.99
- If an image signal from the source selected in **Auto Power On** is input, the projector automatically turns on.
 - ☛ **Extended - Operation - Auto Power On** p.99

Turning Off the Projector



- To ensure a long projector service life, turn off the projector when you are not using it. The light source's operating life varies depending on the Configuration menu settings, environmental conditions, and usage conditions. The brightness of the projected image drops as projection time elapses.
- The projector can be powered off directly by the breaker because it supports the direct shutdown function.
- Whenever the usage time reaches 100 hours, Light Source Calibration starts automatically when the projector is turned off. However, this does not start automatically when the projector is used continuously for more than 24 hours, or when direct shutdown is used regularly. Execute with **Run Now**, or set **Light Source Calibration** using the scheduling function to adjust the light source periodically.
 - ☛ **Reset - Light Source Calibration** p.113
 - ☛ "Setting an Event Schedule" p.71
- If you do not want to start Light Source Calibration automatically, set **Run Periodically** to **Off**.
 - ☛ **Reset - Light Source Calibration - Run Periodically** p.113
- When **Light Source Calibration** is enabled, turn on the projector at least 20 minutes before the event.
- Execute Light Source Calibration to correct the white balance in the light source.

- 1 Press the [⏻] button on the projector, or the [⏻] button on the remote control.

The shutdown confirmation screen is displayed.

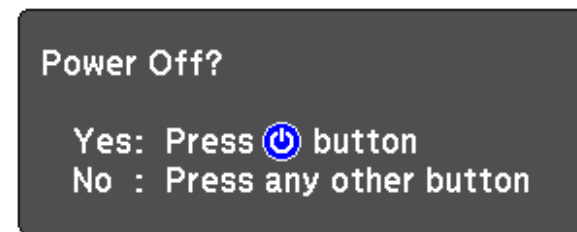

- 2 Press the [⏻] button again, or the [⏻] button on the remote control. (To cancel, press any other button.)

The projected image disappears and the Status indicator turns off.

- 3 To transport or store the projector, make sure the On/Standby indicator is blue (but not flashing) and the status indicator is off, then unplug the power cord.

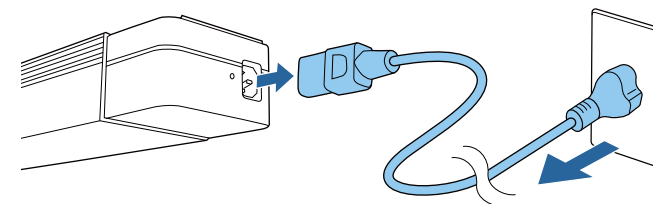

When the projector is installed on a lighting track, turn off the power to the lighting track.

Press the button of the input source that you want to project.

The input ports for the buttons are shown below.

Remote control

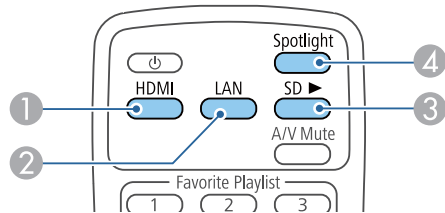

Input Port

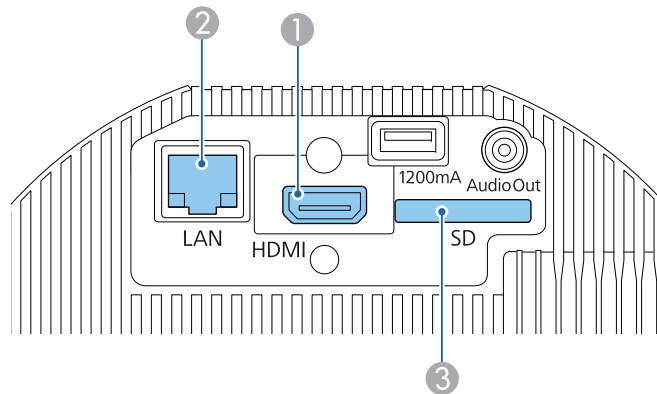

- ② Switches to images from a computer or mobile device connected over a network.
- ④ Switches to Spotlight mode.

You can use the projector's projection light as a Spotlight.

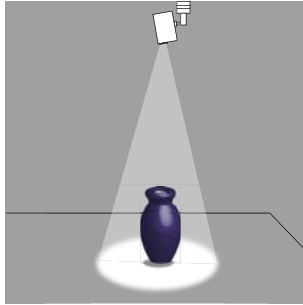

- 1** Press the [Spotlight] button on the remote control.

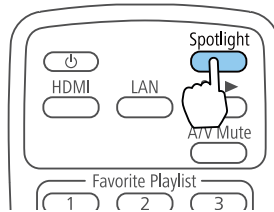

Switches to Spotlight mode.

- 2** Press the [Effect] button on the remote control to change the color and shape.

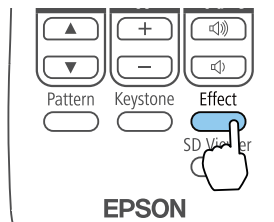

See the following Web site for details.

☛ ["Using Overlay Effect" p.45](#)

You can play a playlist saved on the SD card.

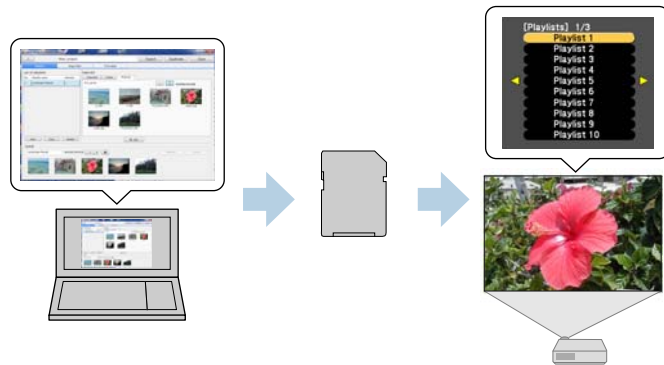

You can create a playlist using Epson Projector Content Manager, Epson iProjection (iOS/Android), or a Web browser.

Download the Epson Projector Content Manager software from the following website.

<http://www.epson.com>

See the "Epson Projector Content Manager Operation Guide" for details on the operation method for Epson Projector Content Manager.

Insert the SD card containing the playlist into the projector.

☛ "Connecting to Various Devices" p.24

Attention

In the following situations, do not unplug the SD card or the power cord from the projector.

Otherwise, data recorded on the SD card may be damaged.

- While playing a playlist
- While displaying a playlist

Playing a Playlist on an SD Card

Press the [SD ▶] button on the remote control to play a playlist saved on the SD card. When an event has been scheduled, the playlist is played according to the schedule in the time table.

☛ "Time Table screen" p.43

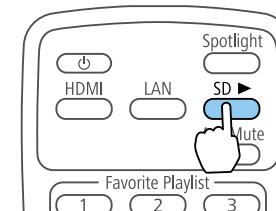

Playing Your Favorite Playlist

You can assign playlists to each of the numeric buttons (1 to 9) on the remote control. By pressing the button to which the playlist is assigned, you can easily access the playlist you want to play.

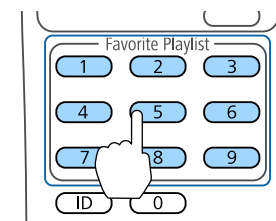

Use Epson Projector Content Manager, Epson iProjection (iOS/Android), or a Web browser to assign playlists to the buttons on the remote control.

Selecting and Playing a Playlist

You can specify a playlist saved on the SD card and play it.

- 1 Press the [SD Viewer] button on the remote control.
A list of playlists saved on the SD card is displayed.

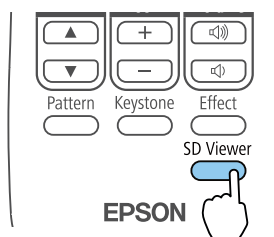

- 2 Use the [▲][▼][◀][▶] buttons to select the playlist you want to play.



The selected playlist is played.

You can operate the projector and edit playlists from mobile devices or computers.

If you are using a mobile device, use Epson iProjection (iOS/Android) to operate the projector.

You can download Epson iProjection (iOS/Android) for free from the App Store or Google Play. Make sure you use version 3.0 or later.



Any fees incurred when communicating with the App Store or Google Play are the responsibility of the customer.

If you are using a computer, use the Epson Web Control function to operate the projector from a Web browser.

For Web browsers, use Internet Explorer 11.0 or later (except for Metro) or Microsoft Edge. For Mac, use Safari.



If you set **Standby Mode** to **Communication On**, you can use the Web browser to make settings and perform control even if the projector is in standby mode (when the power is off).

☛ **Extended - Standby Mode** [p.99](#)

Attention

In the following situations, do not unplug the SD card or the power cord from the projector.

Otherwise, data recorded on the SD card may be damaged.

- While displaying the playlist screen
- While displaying the SD card screen

Operating Using Epson iProjection (iOS/Android)

Use the following procedure to display the Remote screen.

Make sure your device and projector are ready for the network connection.

- 1** Connect your device to the same network as the connected projector.

The connection method varies depending on the device. See the manual supplied with your device for details.

- 2** Start Epson iProjection on your device.

- 3** Press Remote from the menu.

The Remote screen is displayed.

☛ "Remote screen" [p.42](#)



- When you press **Remote** in Epson iProjection, you may be prompted to enter your user name and password. The user name is "EPSONWEB"; the default password is "admin"
- You cannot change the user name. You can change the password in the Network menu from the Configuration menu.
 - ☛ **Network - Basic - Web Control Password** [p.104](#)
- You must enter the user name for Web Control Password even when the password is disabled.

Operating Using Epson Web Control (Web Browser)

Use the following procedure to display the Home screen.

Make sure your device and projector are ready for the network connection.



If your Web browser is set up to connect through a proxy server, the Home screen cannot be displayed. To display Web Control, you need to make settings so that a proxy server is not used for a connection.

1 Connect your device to the same network as the connected projector.

The connection method varies depending on the device. See the manual supplied with your device for details.

2 Start the Web browser on your device.

3 Enter the IP address for the connected projector in the URL field, and then connect.

The Home screen is displayed.



1 Remote

☛ "Remote screen" [p.42](#)

2 Playlists

☛ "Playlists screen" [p.42](#)

3 OSD Control Pad

☛ "OSD Control Pad screen (Epson Web Control only)" [p.44](#)

4 Settings

You are moved to the Settings screen.

5 Advanced

You are moved to the Advanced screen.

6 Crestron Connected

☛ "About Crestron Connected®" [p.144](#)

7 SD Card

☛ "SD Card screen" [p.43](#)

8 Time Table

☛ "Time Table screen" [p.43](#)



- When performing the functions from the Home screen, you may be prompted to enter the user name and password.
The user name is "EPSONWEB"; the default password is "admin"
- You cannot change the user name. You can change the password in the Network menu from the Configuration menu.
☛ **Network - Basic - Web Control Password** [p.104](#)
- You must enter the user name for Web Control Password even when the password is disabled.
- You can only set the following items from the Advanced screen.
 - Monitor Password (up to 16 single-byte alphanumeric characters)
☛ **Network - Basic - Monitor Password** [p.104](#)
 - IPv6 Settings (Manual)
☛ **Network - IPv6 Settings** [p.105, p.108](#)
 - Add HTTP port (for the port number used for Web control, use anything except for 80 (default), 443, 843, 3620, 3621, 3625, 3629, 4352, 4649, 5357, 6454, 10000, 10001, 41794)
☛ **Network - Others** [p.110](#)

Viewing Each Screen

Remote screen

You can perform basic projector operations.

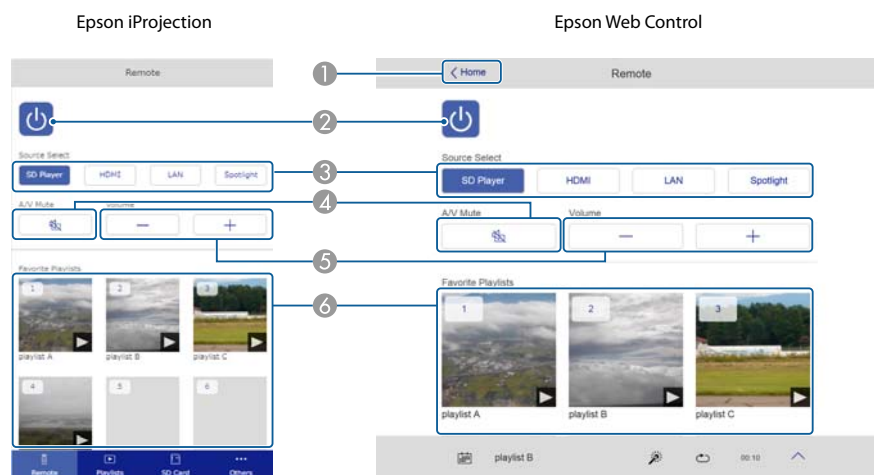

- ① Moves to the Home screen. (Epson Web Control only)
- ② Turns the projector on or off.
- ③ Switches to the target image.
- ④ Turns the video and audio on or off.
- ⑤ You can adjust the volume.
- ⑥ Select your favorite playlist.

Playlists screen

You can control your playlists.

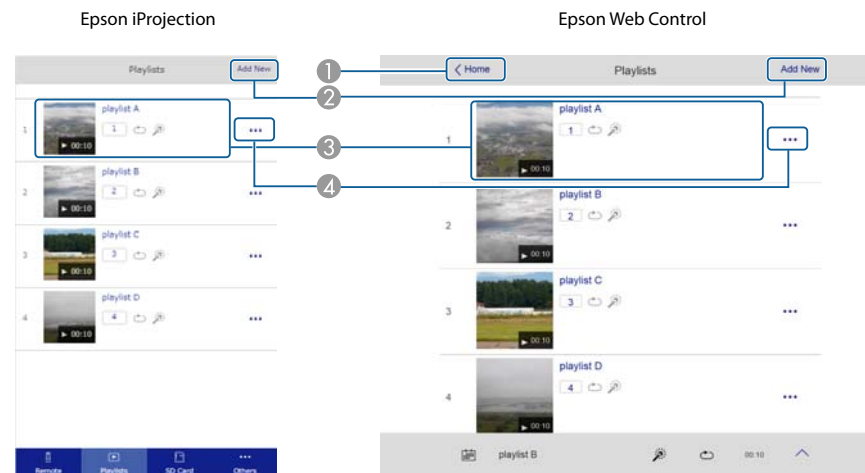

- ① Moves to the Home screen. (Epson Web Control only)
- ② Create a new playlist.
- ③ Play, stop, set effects, use A/V mute, and adjust the volume for the playlist.
- ④ Edit and copy playlists, and add or delete your favorite playlists.

SD Card screen

You can operate the SD card inserted in the projector.

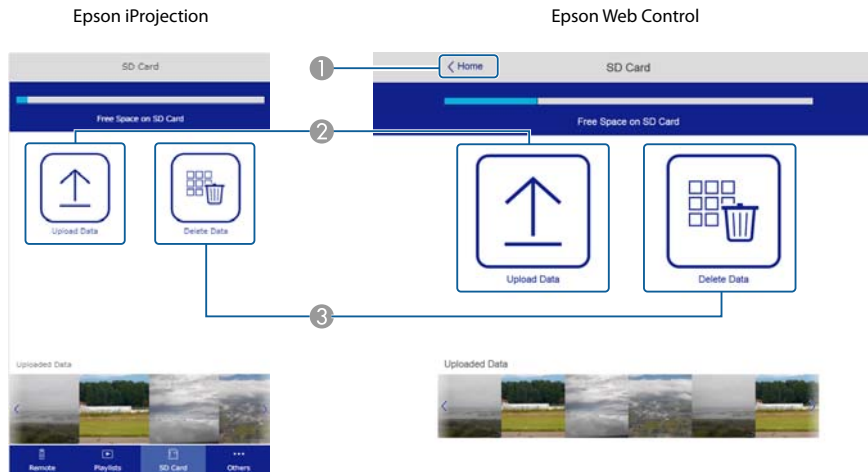

- ① Moves to the Home screen. (Epson Web Control only)
- ② Transfers data (movies or still images used for playlists) to the SD card.
- ③ Deletes data from the SD card.

Time Table screen

You can browse the time table.

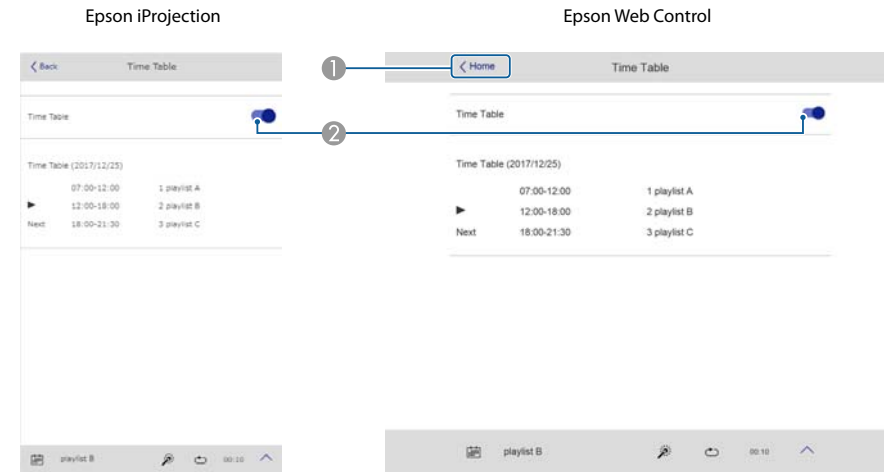

- ① Moves to the Home screen. (Epson Web Control only)
- ② Turns the time table on or off.



By using the Epson Projector Content Manager's time table function, you can specify the date and time to play the playlist. See the Epson Projector Content Manager Operation Guide for instructions.

OSD Control Pad screen (Epson Web Control only)

You can operate the Configuration menu of the projector.

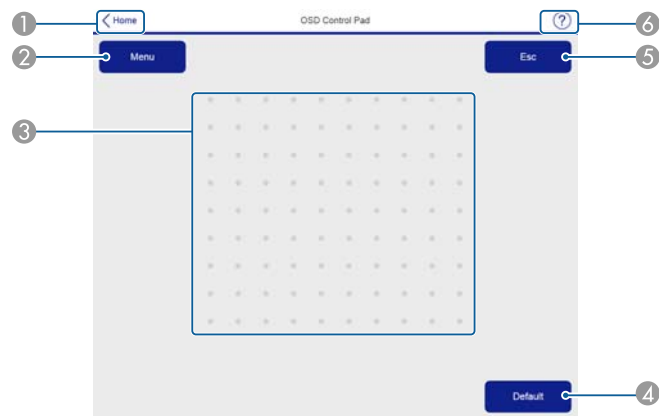

- ① Moves to the Home screen. (Epson Web Control only)
- ② Displays and closes the Configuration menu.
- ③ You can operate the Configuration menu using your finger or mouse.
Click to select an item, and tap to confirm the selection.
- ④ Enabled when [Default]: Reset is displayed on the Configuration menu guide. The settings being adjusted are returned to their default values.
- ⑤ Returns to the previous menu level in the Configuration menu.
- ⑥ Displays information on using the OSD Control Pad.

You can set the following effects for Spotlight or projected images.

- Blur the edges of the image
- Change the shape of the image
- Change the color of the image
- Adjust the brightness of the image



Attention

Do not unplug the SD card or power cord from the projector while operating Overlay Effect. Otherwise, data recorded on the SD card may be damaged.



You can set Overlay Effect for each input source. For SD cards, you can set effects for each playlist.

Setting the Shape of the Effect

- 1 Press the [Effect] button while projecting Spotlight or images.

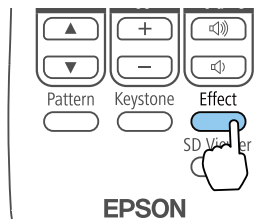

The following screen is displayed.

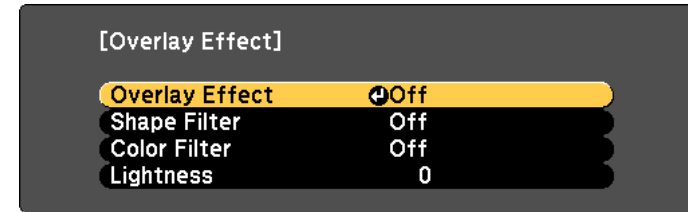

[◀]:Select [↵]:Enter [Menu]:Exit

- 2 Set **Overlay Effect** to **On**.
- 3 Select **Shape Filter**, and then press the [↵] button.
- 4 Use the [▲][▼] buttons to select the item you want to set, and then press the [↵] button.

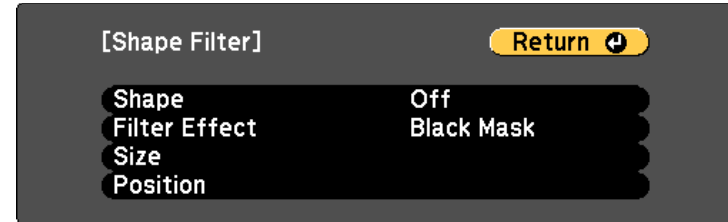

[Esc]/[↵]:Return [◀]:Select [Menu]:Exit

Shape: You can select the shape of the effect from a circle, square, or make a custom shape. If you are not using Shape Filter, select Off.

Filter Effect: Select whether to mask the color of the mask as well as the inside of the selected shape, or to mask the outside.

Size: Use the [◀][▶] buttons to set **Height** and **Width** for the selected shape.

Position: Use the [▲][▼][◀][▶] buttons to set the position in which to display the selected shape.



You can create custom shapes using Epson Projector Content Manager.

- 5 Press the [Effect] button or the [Menu] button to finish making settings.

Adjusting the Color of the Effect

- 1 Press the [Effect] button while projecting Spotlight or images.

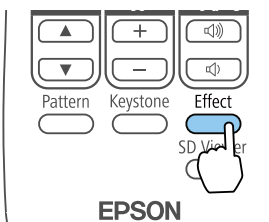

The following screen is displayed.

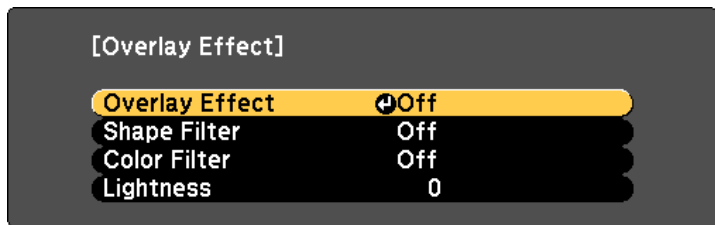

[◀]:Select [↵]:Enter [Menu]:Exit

- 2 Set **Overlay Effect** to **On**.
- 3 Select **Color Filter**, and then press the [↵] button.

- 4 Select **Color Filter**, and then use the [◀][▶] buttons to select the color you want to set. To set a color that is not available in this setting, select **Custom**.

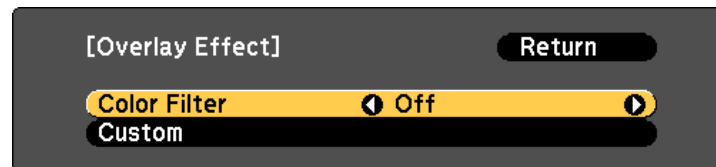

[Esc]:Return [◀▶]:Select [Menu]:Exit
[Default]:Reset

- 5 To adjust the color for **Custom**, select **Custom**, and then press the [↵] button.

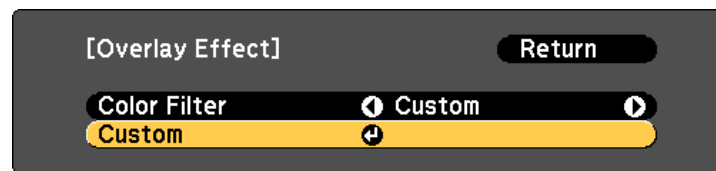

[Esc]:Return [◀▶]:Select [↵]:Enter [Menu]:Exit

- 6 Use the [▲][▼] buttons to select the color, and then use the [◀][▶] buttons to make the adjustments.



[Esc]/[↵]:Return [◀▶]:Select [Menu]:Exit

- Press the [Effect] button or the [Menu] button to finish making settings.

Adjusting the Brightness of the Overlay Effect

- Press the [Effect] button while projecting Spotlight or images.

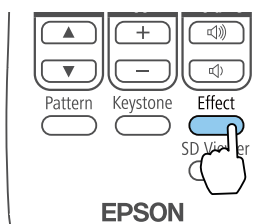

The following screen is displayed.

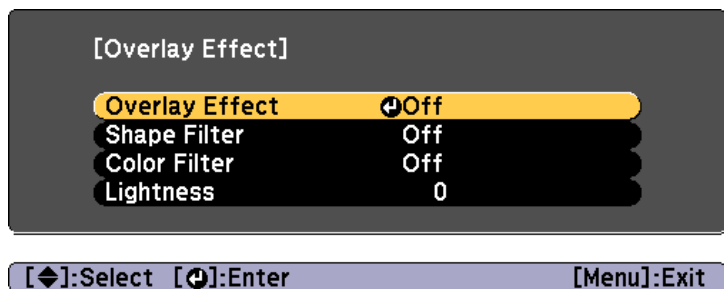

- Set **Overlay Effect** to **On**.
- Select **Lightness**, and then press the [↵] button.
- Use the [◀][▶] buttons to adjust the Lightness.

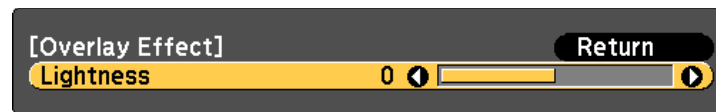

- Press the [Effect] button or the [Menu] button to finish making settings.



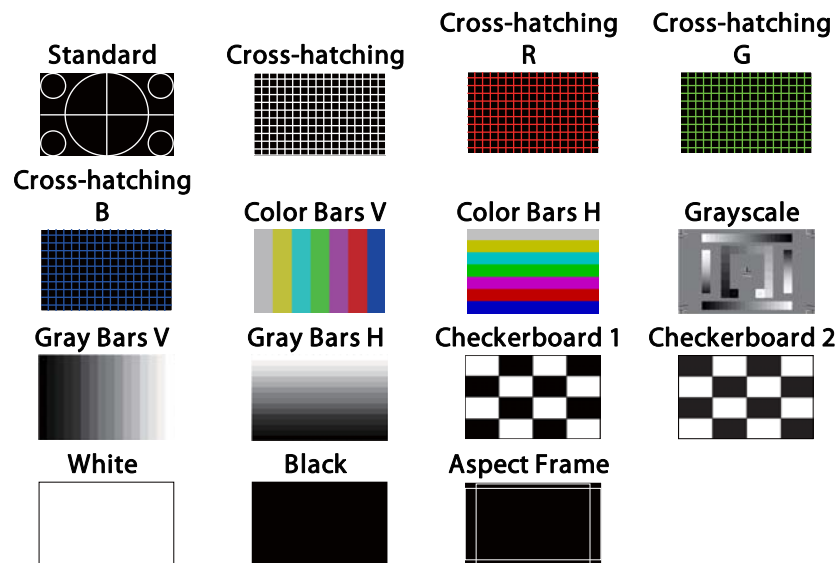
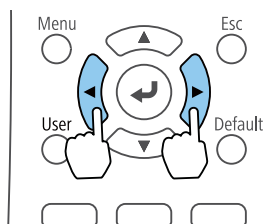

Displaying a Test Pattern

A test pattern can be displayed to adjust the projection status without connecting video equipment.

- 1 Press the [Pattern] button while projecting.
- 2 Press the [◀][▶] buttons on the remote control to change test pattern.



In addition to lens operations, the following image adjustments can be made while the test pattern is being displayed.

Top Menu Name	Sub Menu/Items
Image	Color Mode  p.52
	White Balance
	Advanced - Gamma  p.55
	Dynamic Contrast  p.54
	Reset
Settings	Keystone  p.49
	Brightness Settings
Extended	Multi-Projection*  p.60

* Except for Color Uniformity and Scale



- To set menu items that cannot be set while the test pattern is being displayed or to fine-tune the projected image, project an image from the connected device.
- You can also select a test pattern from the Configuration menu.
 - ☛ **Settings - Test Pattern p.98**

3 Press the [Esc] button to close the test pattern.

Adjusting the Image Size

1 Press the [Zoom] (+/-) buttons on the remote control to adjust the zoom.

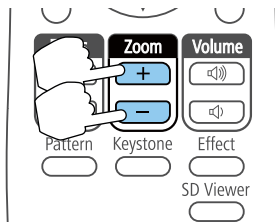

2 Press the [Esc] button to finish the adjustment.



- When minimizing the size of the image using the optical zoom, a message is displayed and the projector switches to digital zoom.
- When maximizing the size of the image using the digital zoom, a message is displayed and the projector switches to optical zoom.

Correcting the Focus

1 Press the [Focus] (▲/▼) buttons on the remote control to adjust the focus.

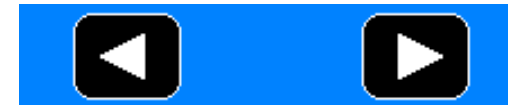
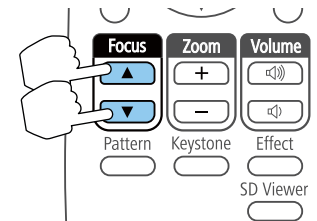

The focus adjustment screen is displayed in blue so that it is easy to see even if it is out of focus.

2 Press the [Esc] button to finish the adjustment.

Correcting Distortion in the Projected Image

You can correct keystone distortion in projected images using one of the following methods.

- Correcting H/V-Keystone
This allows you to correct distortion in the horizontal and vertical directions independently.
☛ "Correcting H/V-Keystone" p.50

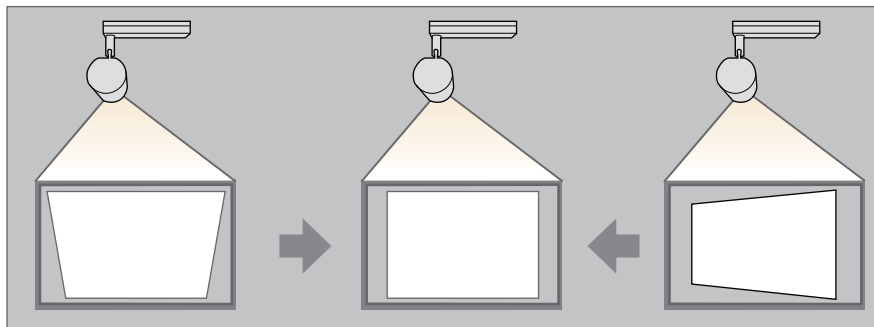

- Quick Corner
Correct the four corners independently.
☛ "Quick Corner" p.51

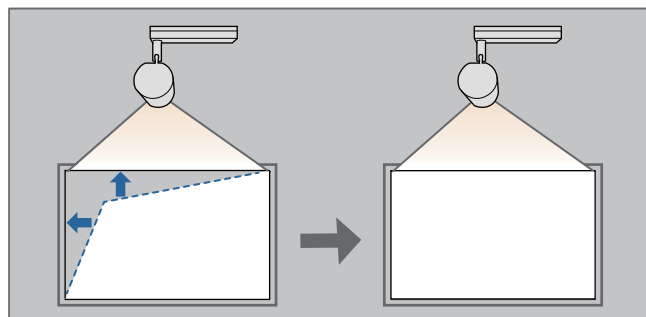

Correcting H/V-Keystone

This allows you to correct distortion in the horizontal and vertical directions independently.

- 1 Press the [Keystone] button while projecting.

- 2 Select **H/V-Keystone**, and then press the [↵] button.

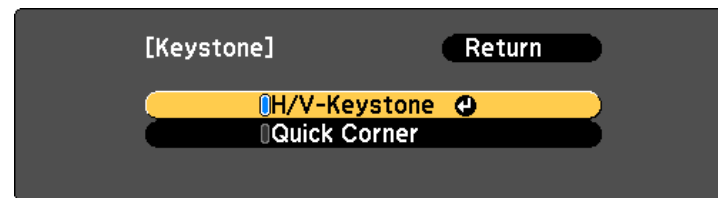

[Esc] :Return [◆]:Select [⏎]:Enter [Menu]:Exit

"If this setting is changed, the image may be distorted." is displayed, press the [↵] button.

- 3 Use the [▲][▼] buttons to select the correction method, and then correct using the [◀][▶] buttons.



[Esc] / [⏎]:Return [◆]:Select [Menu]:Exit

[Pattern]: Show

Correct the keystone distortion by using **V-Keystone** and **H-Keystone**.

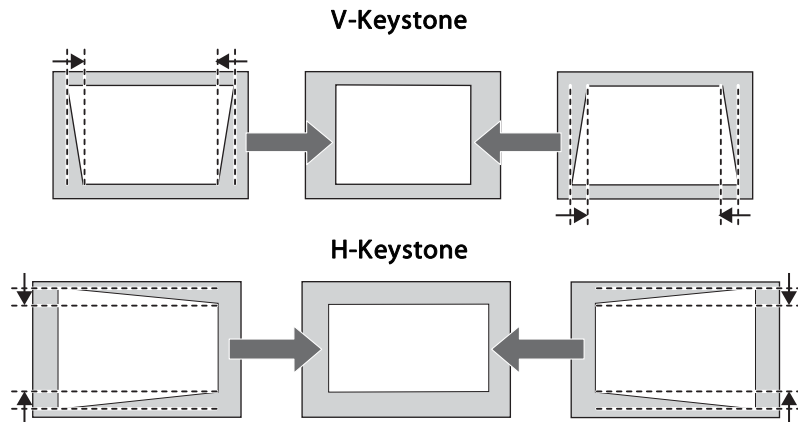

When you correct keystone distortion, the projected image may be reduced.

4 Press the [Menu] button to finish making corrections.

You cannot combine with other correction methods.

Quick Corner

This allows you to correct each of the four corners of the projected image independently.

- 1** Press the [Keystone] button while projecting.
- 2** Select **Quick Corner**, and then press the [↵] button.

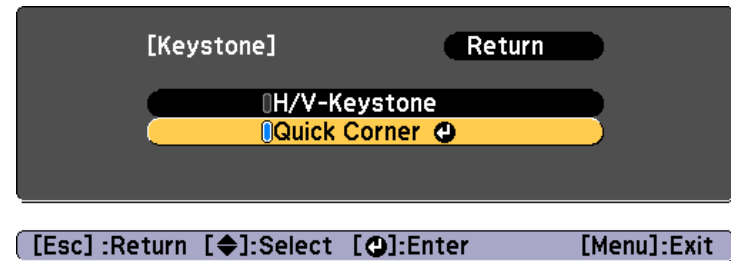

"If this setting is changed, the image may be distorted." is displayed, press the [↵] button again.

3 Use the [▲], [▼], [◀], and [▶] buttons to select the corner you want to adjust, and then press the [↵] button.

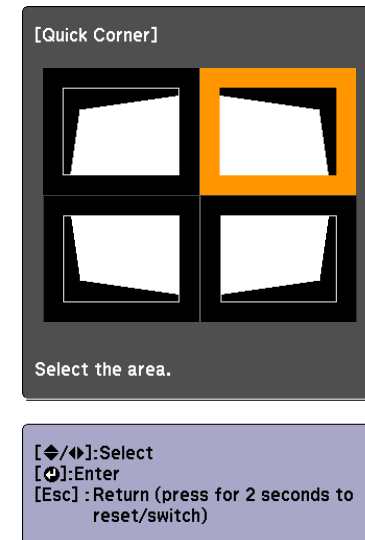

If the [Esc] button is pressed for approximately two seconds, the confirm default reset screen is displayed. Select **Yes** to reset the result of Quick Corner corrections.

- Use the [▲], [▼], [◀], and [▶] buttons to correct the position of the corner.

When you press the [↵] button, the screen shown in step 4 that allows you to select the area to be corrected is displayed.

If the message "Cannot adjust any further." is displayed while adjusting, you cannot adjust the shape any further in the direction indicated by the gray triangle.

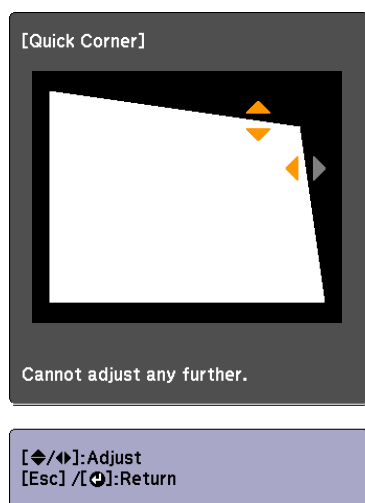

- Repeat steps 3 and 4 as needed to adjust any remaining corners.
- Press the [Menu] button to finish making corrections.

Selecting the Projection Quality (Selecting Color Mode)

You can easily obtain the optimum image quality by selecting the Color Mode that best corresponds to your surroundings when projecting. The brightness of the image varies depending on the mode selected.

- Press the [Menu] button while projecting.
- Select **Color Mode** from **Image**.

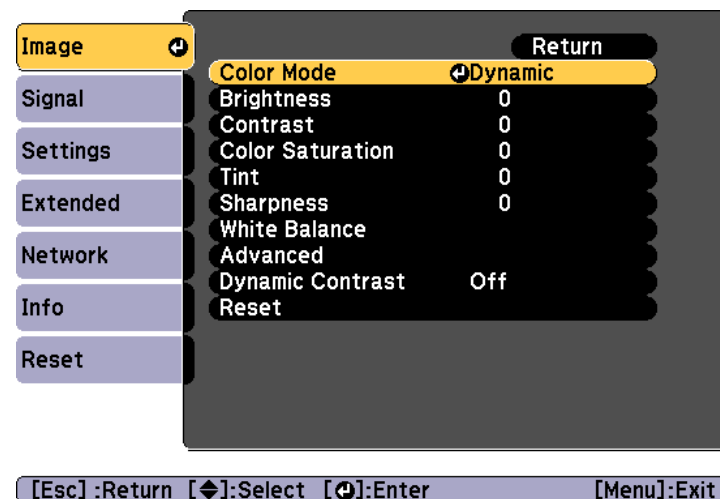

- Select the item you want to set, and then press the [↵] button.
Dynamic: This is the brightest mode. Ideal for use in a bright room.
Normal: This tones down the brightness of the image more than **Dynamic**, and provides images with natural colors.
- Press the [Menu] button to finish making settings.

Setting the Brightness

Set the brightness for the light source.

- Press the [Menu] button while projecting.

2 Select **Brightness Settings** from **Settings**.

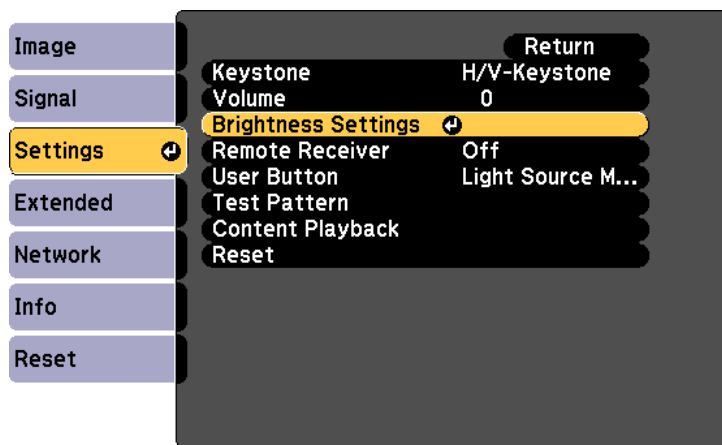

[Esc] :Return [↕]:Select [↵]:Enter [Menu]:Exit

3 Select **Light Source Mode**, and then press the [↵] button.

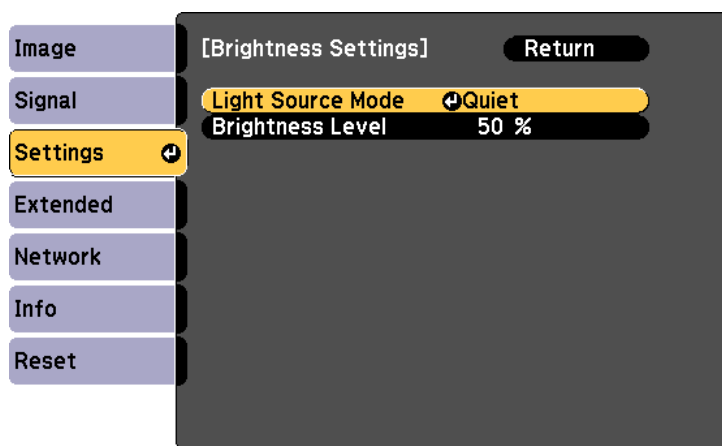

[Esc] :Return [↕]:Select [↵]:Enter [Menu]:Exit

4 Select the item you want to set, and then press the [↵] button.

Normal: Select this if you do not want to decrease the brightness. This makes the target usage time approximately 20,000 hours.

Quiet: Select this if you are concerned about the noise made by the fan. This sets the brightness at 50%. This makes the target usage time approximately 20,000 hours.

Extended: Select this to extend the life expectancy of the light source. This sets the brightness at 50%. This makes the target usage time approximately 30,000 hours.

Custom: Select this to set the brightness level within a range of 50 to 100%.

5 When **Light Source Mode** is set to **Custom**, select **Brightness Level**, and then use the [◀][▶] buttons to set the brightness.



There may be a margin of error in the **Brightness Level**.

6 Press the [Menu] button to finish making settings.

Setting the Amount of Light of the Projected Image

By automatically setting the luminance according to the brightness of the displayed image, it lets you enjoy deep and rich images.

- 1 Press the [Menu] button while projecting.
- 2 Select **Dynamic Contrast** from **Image**, and then press the [↵] button.

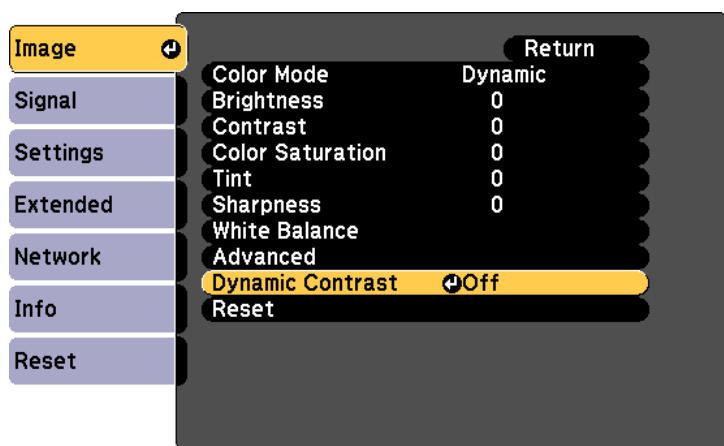

[Esc]:Return [↕]:Select [↵]:Enter [Menu]:Exit

- 3 Select **Normal** or **High Speed**, and then press the [↵] button. The setting is stored for each **Color Mode**.
- 4 Press the [Menu] button to finish making settings.

Changing the Aspect Ratio of the Projected Image

You can change the Aspect Ratio of the displayed image.



- You can only set the **Aspect** when the input signal is HDMI.
- The available settings depend on the input source being projected.

- 1 Press the [Menu] button while projecting.
- 2 Select **Aspect** from **Signal**, and then press the [↵] button.

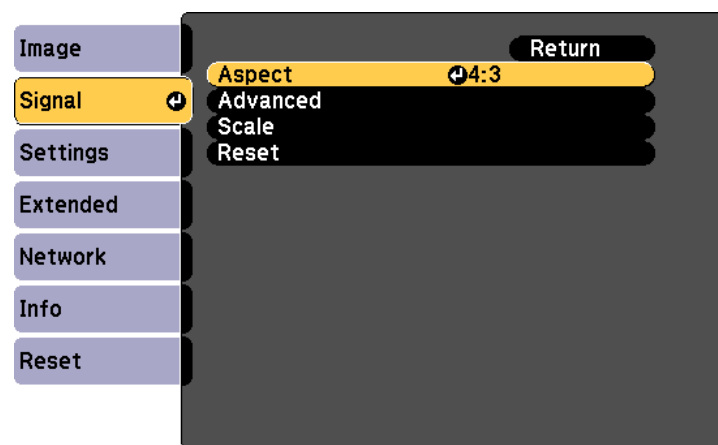

[Esc]:Return [↕]:Select [↵]:Enter [Menu]:Exit

- 3 Use the [▲][▼] buttons to select the item you want to set, and then press the [↵] button.







Aspect Mode	Explanation
Auto	Projects in an appropriate aspect ratio based on information from the signal being input.
Normal	Projects while retaining the aspect ratio of the input image.



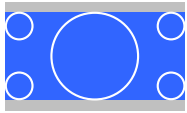
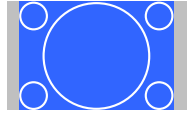
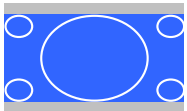

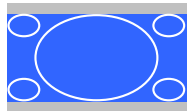
Aspect Mode	Explanation
4:3	Projects at an aspect ratio of 4:3.
16:9	Projects at an aspect ratio of 16:9.
Full	Projects at the full size of the projected screen.
Zoom	Projects by enlarging the input image to the full width of the projected screen while retaining the aspect ratio. Areas that exceed the edges of the projected screen are not projected.
Native	Projects to the center of the projected screen at the resolution of the input image. Areas that exceed the edges of the projected screen are not projected.

4 Press the [Menu] button to finish making settings.

The aspect mode changes as shown in the tables below.

: The area where the image is not displayed depending on the aspect mode setting.

	Aspect Ratio of Input Signal		
	16:10	16:9	4:3
Auto or Normal			
16:9			
Full			

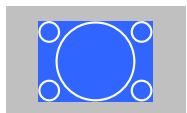
	Aspect Ratio of Input Signal		
	16:10	16:9	4:3
Zoom			
Native*			

* The image may differ depending on the resolution of the input signal.

Adjusting the Gamma Value of the Projected Image

You can adjust differences in the halftone brightness that occurs depending on the connected device.



Adjust by projecting a still picture. Gamma cannot be adjusted correctly by using movies.

- 1** Press the [Menu] button while projecting.
- 2** Select **Advanced** from **Image**, and then press the [] button.

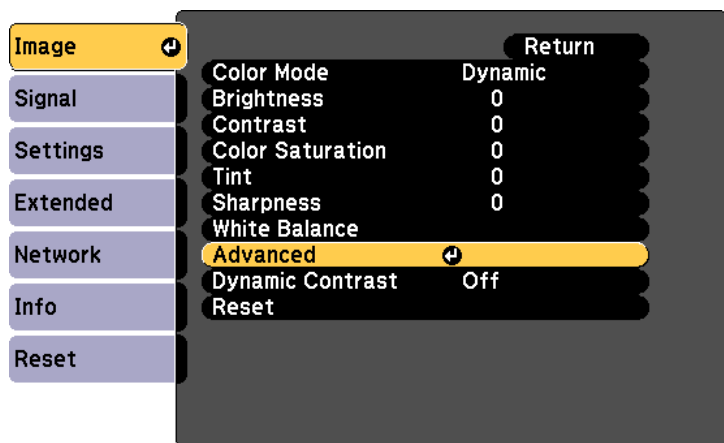

[Esc] :Return [◆]:Select [⏏]:Enter [Menu]:Exit

- 3 Select **Gamma**, and then press the [↵] button.
- 4 Use the [▲][▼] buttons to select the correction value, and then use the [↵] button to confirm the selection.

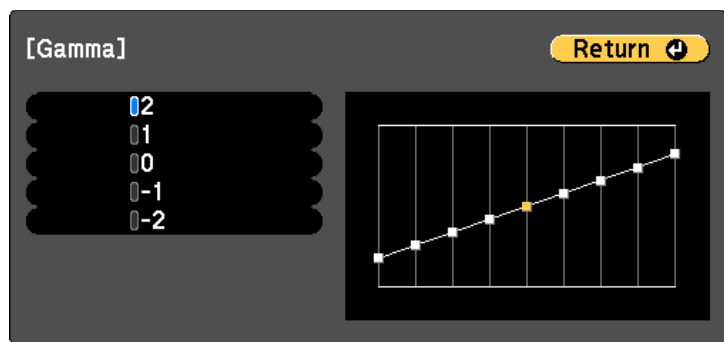

[Esc] / [⏏]:Return [◆]:Select [Menu]:Exit

When a smaller value is selected, you can reduce the overall brightness of the image to make the image sharper.

- 5 Press the [Menu] button to finish making settings.

When a larger value is selected, the dark areas of images become brighter, but the color saturation for lighter areas may become weaker.

You can adjust the volume of the audio output from the external speaker connected to the Audio Out port using one of the following methods.

- Press the [Volume] buttons on the remote control to adjust the volume.
 - [<|>] Increases the volume.
 - [<|>] Decreases the volume.

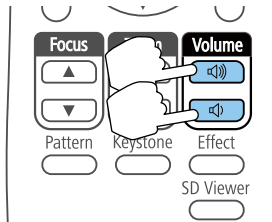

- Adjust the volume from the Configuration menu.
 - ☛ **Settings - Volume** [p.98](#)

Caution

Do not start at high volume.
A sudden excessive volume may cause loss of hearing. Always lower the volume before powering off, so that you can power on and then gradually increase the volume.

You can temporarily hide the projected image and mute the audio. Any sound or video action continues to run, however, so you cannot resume projection at the point that you stopped it.

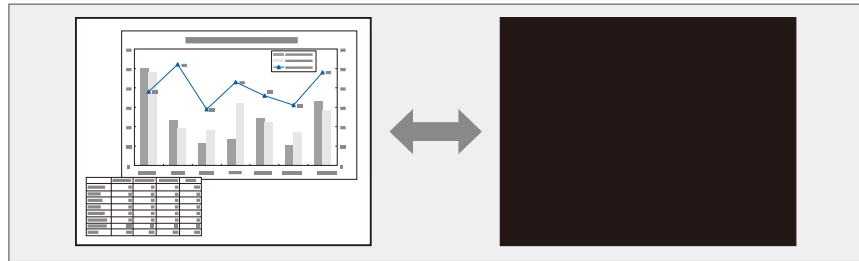

Each time you press the [A/V Mute] button on the remote control, A/V Mute turns on or off.

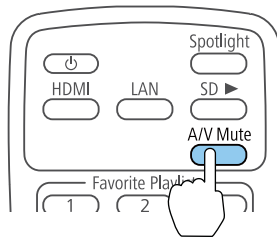



Useful Functions

This section describes the Multi-Projection function and synchronized playback.

You can setup multiple projectors to project one large image. You can adjust the difference of brightness and color tone between each projected image to create a seamless screen.



- We recommend setting the focus and zoom at least 20 minutes after you start projecting, because images are not stable right after turning on the projector.
- If the values for **Keystone** are large, it can be difficult to adjust the image position for overlapping images.
- The Test Pattern can be displayed to adjust the projection status without connecting video equipment.
 - ☛ "Displaying a Test Pattern" [p.48](#)
- If you project a dot by dot image that can be projected without being enlarged or reduced, you can make adjustments precisely.

- (3) Adjust the zoom and focus.
 - ☛ "Adjusting the Image Size" [p.49](#)
 - ☛ "Correcting the Focus" [p.49](#)
- (4) Adjust the edges of the images.
 - ☛ "Adjusting the Points Where the Images Overlap (Edge Blending)" [p.62](#)
- (5) Select the sections of the images.
 - ☛ "Displaying a Scaled Image" [p.64](#)

Adjustment Procedure

Advance preparation

- (1) Turn on all projectors.
- (2) Set an ID for all projectors and the remote controls.
 - ☛ "Set the projector ID" [p.61](#)

Adjusting the projected images

- (1) Adjusting the projected position.
 - ☛ "Adjust the projection angle using the ball joint" [p.22](#)
 - ☛ "Setting the Image Orientation (Projection)" [p.28](#)
 - ☛ "Correcting Distortion in the Projected Image" [p.49](#)
- (2) Adjust the aspect ratio of the images.
 - ☛ "Changing the Aspect Ratio of the Projected Image" [p.54](#)

Setting the Projector ID

When an ID is set for the projector and the remote control, you can use the remote control to operate only the projector with a matching ID. This is very useful when managing multiple projectors. You can set up to 9 IDs.



Operation using the remote control is possible only for projectors that are within the operating range of the remote control.

☛ "Remote control operating range" [p.27](#)

Set the projector ID

- 1** Press the [Menu] button while projecting.
☛ "Using the Configuration Menu" [p.92](#)
- 2** Select **Multi-Projection** from **Extended**.
- 3** Select **Projector ID**, and then press the [↵] button.
- 4** Press the [▲][▼] buttons to select an ID number.

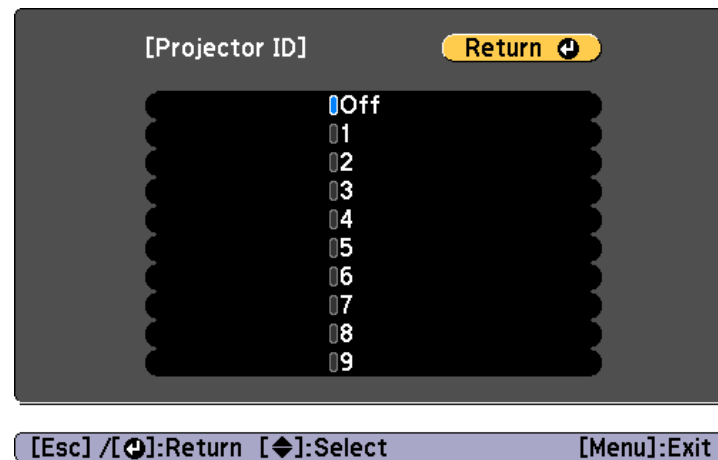

- 5** Press the [↵] button.
- 6** Press the [Menu] button to finish making settings.

Repeat these steps for all the other projectors you want to operate from one remote control.

Selecting the Projector You want to Operate

After setting the projector's ID, select the ID for the projector you want to operate using the remote control.

- 1** Aim the remote control at the target projector and press the [ID] button.

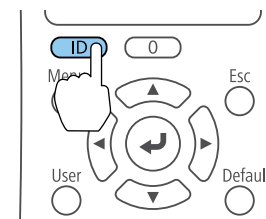

The current Projector ID is displayed on the projected screen. It disappears after about 3 seconds.



- 2 While holding the [ID] button, press the number button that matches the ID of the projector you want to operate.

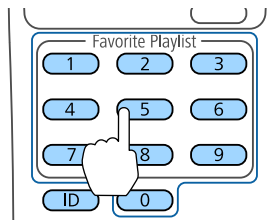

The projector you want to operate is selected.

- 3 Press the [ID] button to check if the ID-setting process worked. You see a message displayed by the projector.
 - If the remote control is listed as **On**, you can operate the projector from the remote control.
 - If the remote control is listed as **Off**, you cannot operate the projector from the remote control. Repeat the steps above to enable the remote control.



- When you select 0 on the remote control, you can operate all projectors regardless the Projector ID setting.
- You must select the projector ID from the remote control each time you turn on the projector you have set it to control. When you turn on the projector, 0 is selected as the remote control's projector ID.
- When you set the **Projector ID** setting to **Off**, you can operate the projector using the remote control whichever ID you select on the remote control.

Adjusting the Points Where the Images Overlap (Edge Blending)

You can fine tune the overlapping areas to make seamless screen.

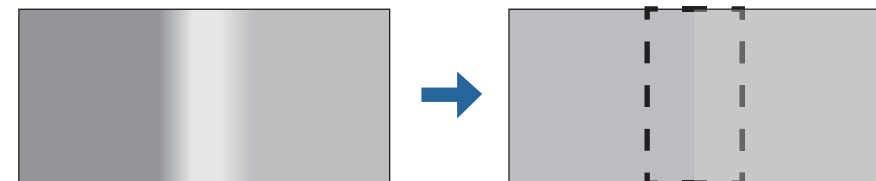

- 1 Press the [Menu] button while projecting.
- 2 Select **Multi-Projection** from **Extended**.
- 3 Select **Edge Blending**, and then press the [**↩**] button. The following screen is displayed.

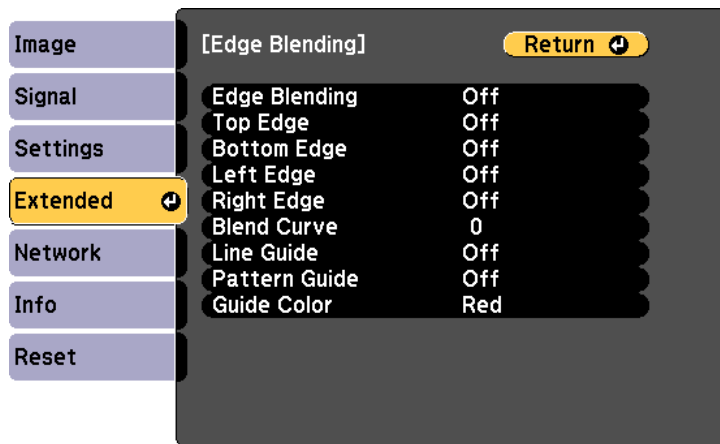

[Esc] / [⏏]:Return [⏏]:Select [Menu]:Exit

Submenu	Function
Edge Blending	Set to On to activate Edge Blending.
Top Edge/Bottom Edge/Left Edge/Right Edge	Blending: Set to On to activate Edge Blending towards your settings, and the blend range will be shaded. Blend Range: Adjusts the range to be shaded. Adjustment is possible at the level of one pixel. The maximum range is 45% of the resolution.
Blend Curve	You can select from 3 ways of shading.
Line Guide	Set to On to display a guide on the Edge Blending setting range.
Pattern Guide	Set to On to display a guide to match the position of the Edge Blending setting range.
Guide Color	Select a combination of guide colors from the three provided.

4 Set **Edge Blending** to **On**.

5 Set **Line Guide** to **On**.



If the guide is not clear, you can change the color of the guide in **Guide Color**.

6 Set **Pattern Guide** to **On**.

7 Set **Top Edge**, **Bottom Edge**, **Left Edge**, or **Right Edge** according to the parts of the image that are overlapped.

The following shows how to set screen (1) as an example.

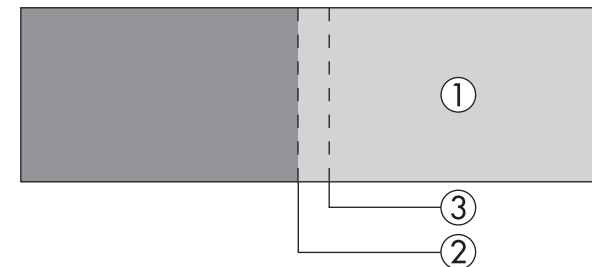

In the example above, you need to adjust the **Left Edge** because you can see the overlapping areas on the left side of the image (1).

- (1) Select **Left Edge**, and then press the [↵] button.
- (2) Select **Blending**, and then press the [↵] button.
- (3) Select **On**, and then press the [↵] button.
- (4) Press the [Esc] button.

- (5) In **Blend Range**, adjust the range (3) to be shaded.
The value for when the overlapped range and the guide are in the same position is the best.

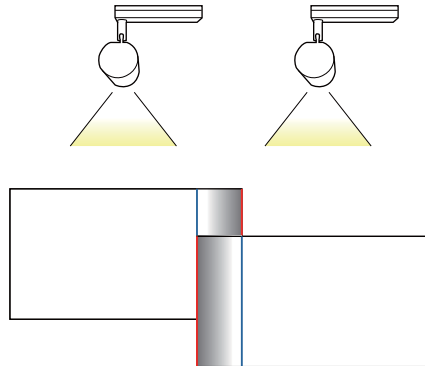

- (6) Press the [Esc] button.

8 Set **Blend Curve**.

- (1) Select **Blend Curve**, and then press the [↵] button.
- (2) Select the amount of shading from **1** to **3**, and then press the [↵] button.
- (3) Press the [Esc] button.

9 After the settings are complete, set **Line Guide** and **Pattern Guide** to **Off** to finish.

Displaying a Scaled Image

A section of the image is cropped and displayed. This allows you to create one large image by combining images projected from multiple projectors.

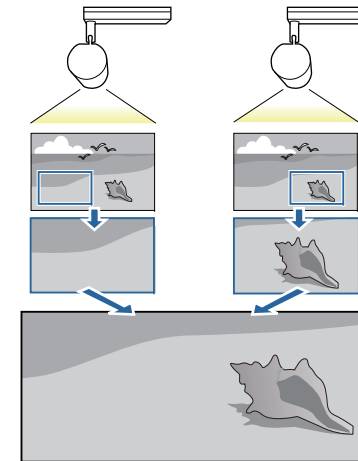

- 1** Press the [Menu] button while projecting.

- 2** Select **Multi-Projection** from **Extended**.



You can also perform the same operation from **Scale** in **Signal**.

- 3** Select **Scale**, and then press the [↵] button.

- 4** Set **Scale** to **On**.

5 Select **Scale Mode**.

Zoom Display: Adjusts according to the image currently displayed.

Enlarge



Move

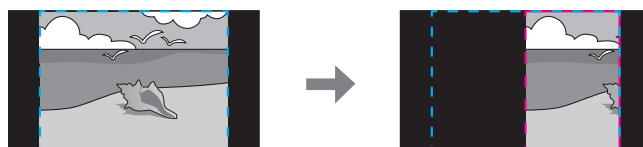

Full Display: Adjusts according to the projector's panel size (the maximum area in which an image can be displayed).

Enlarge



Move



6 Adjust the scale.

Select the adjustment method with the [▲][▼] buttons, then adjust using the [◀][▶] buttons.

-+: Enlarges or reduces an image horizontally and vertically at the same time.

Scale Vertically: Enlarges or reduces an image vertically.

Scale Horizontally: Enlarges or reduces an image horizontally.

7 The image is clipped and adjusted.

- (1) Select **Clip Adjustment**, and then press the [↶] button.
If you select **Clip Range**, the range and coordinates of the image that the projector will project is displayed.
- (2) Use the [▲], [▼], [◀], and [▶] buttons to scroll the image.
Adjust the coordinates and size of each image while viewing the screen.



You can check the displayed area after clipping for the entire image from **Clip Range**.

8 Press the [Menu] button to finish making adjustments.

Adjusting Multiple Projected Images

Adjusting uneven colors (Color Uniformity)

Adjusts the color tone for the whole screen.



The color tone may not be uniform even after performing Color Uniformity.

1 Press the [Menu] button while projecting.

- 2 Select **Multi-Projection** from **Extended**.
- 3 Select **Color Uniformity**, and then press the [↵] button.

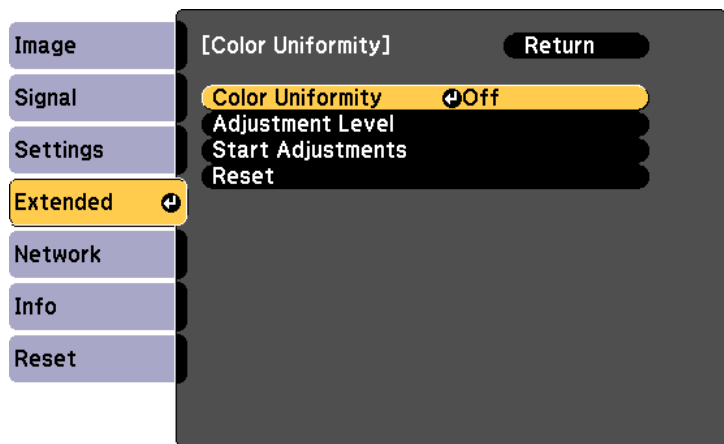

[Esc] :Return [↓]:Select [↵]:Enter [Menu]:Exit

Color Uniformity: Turns Color Uniformity **On** or **Off**.

Adjustment Level: There are eight levels from white, through gray, and up to black. You can adjust each level individually.

Start Adjustments: Starts adjusting Color Uniformity.

Reset: Resets all adjustments and settings for **Color Uniformity** to their default values.



The image may become distorted while adjusting **Color Uniformity**. The image is restored once adjustments are complete.

- 4 Set **Color Uniformity** to **On**.
- 5 Select **Adjustment Level**, and then press the [↵] button.

- 6 Use the [◀][▶] buttons to set the adjustment level.
- 7 Press the [Esc] button to return to the previous screen.
- 8 Select **Start Adjustments**, and then press the [↵] button.
- 9 Select the area you want to adjust, and then press the [↵] button.

Adjust the outer areas first, and then adjust the whole screen.

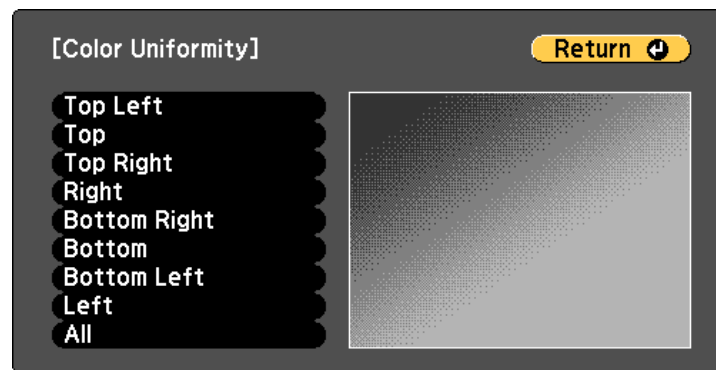

[Esc] / [↵]:Return [↓]:Select [Menu]:Exit

- 10 Use the [▲][▼] buttons to select the color, and then use the [◀][▶] buttons to make the adjustments.
Press the [◀] button to weaken the color tone. Press the [▶] button to strengthen the color tone.

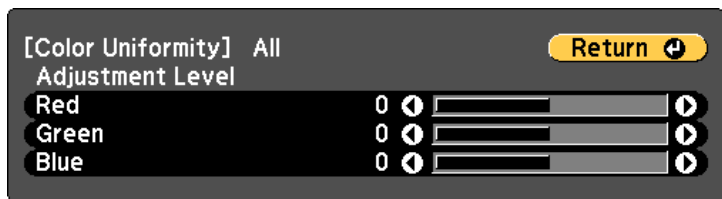

[Esc] / [⏪]:Return [⏩]:Select [Menu]:Exit

- 11** Return to step 5 and adjust each level.
- 12** Press the [Menu] button to finish making adjustments.

Adjusting the tint (Color Matching)

Adjust the color for each image.

Turn on all of the projectors, and then adjust **Color Matching** from the **Extended** menu for each projector. Adjust so that the colors and brightness are uniform for the entire projected image.

- 1** Press the [Menu] button while projecting.
- 2** Select **Multi-Projection** from **Extended**.
- 3** Select **Color Matching**, and then press the [↵] button.

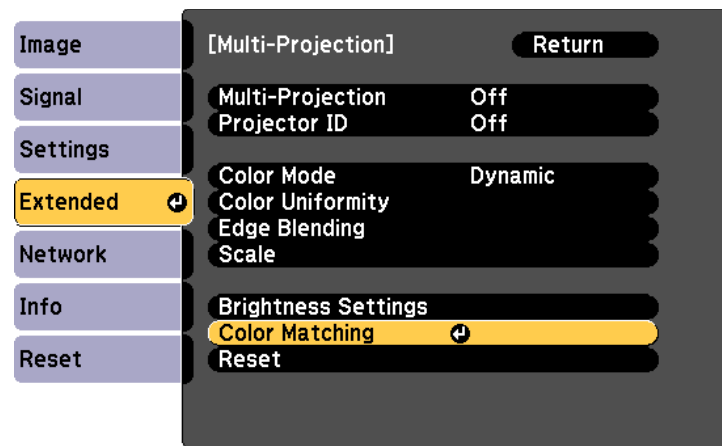

[Esc] :Return [⏩]:Select [↵]:Enter [Menu]:Exit

The following screen is displayed.

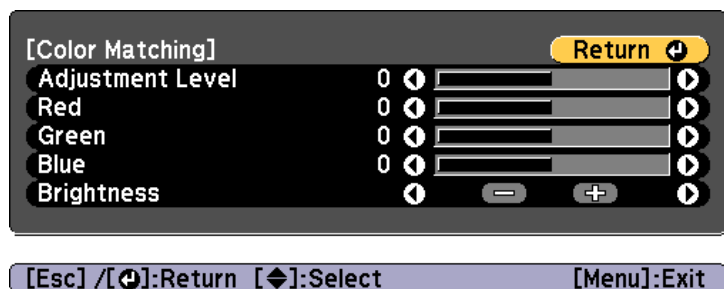

Half of the overlapped area is displayed in black so that it is easy to check the edge of the image.

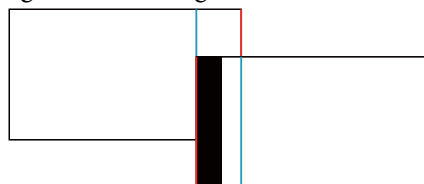

Adjustment Level: There are eight levels from white, through gray, and up to black. You can adjust each level individually.

Red, Green, Blue: Adjusts the tone for each color.

Brightness: Adjusts the image brightness.



Whenever the [Left Arrow] button is pressed, the screen changes between the projected image and the adjustment screen.

- 4 Select **Adjustment Level**, and then use the [Left Arrow][Right Arrow] buttons to set the adjustment level.
- 5 Select **Red**, **Green**, or **Blue**, and then press the [Left Arrow][Right Arrow] buttons to adjust the color tone.

- 6 Select **Brightness**, and then use the [Left Arrow][Right Arrow] buttons to adjust the brightness.
- 7 Return to step 1 and adjust each level.
- 8 Press the [Esc] button to return to the previous screen.

You can play the same playlist at the same time on multiple projectors.

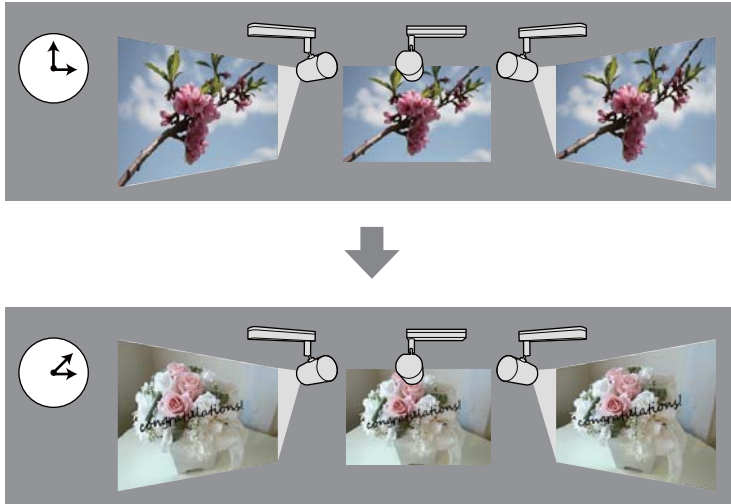

Create and schedule playlists using Epson Projector Content Manager. See the "Epson Projector Content Manager Operation Guide" for details on the operation method for Epson Projector Content Manager.

Set the projector name and the correct date/time in advance for all projectors that will be performing synchronized playback.

- ☛ **Basic - Projector Name** [p.104](#)
- ☛ "Setting the Date and Time" [p.30](#)



- The playback timings may change depending on the network status. We recommend connecting over a wired LAN.
- You can also create playlists using Epson iProjection (Android/iOS) or a Web browser.
 - ☛ "Operating the Projector Using a Mobile Device or Computer" [p.40](#)
- See the following to adjust the color for multiple projectors that are projecting side-by-side.
 - ☛ "Adjusting uneven colors (Color Uniformity)" [p.65](#)

Starting Synchronized Playback

- 1** Insert an SD card into the projector.
- 2** Press the [SD ▶] button on the remote control.
- 3** Synchronized playback starts at the date/time specified in the time table.

Set the image (User's Logo) you want to display when the projector is turned on. You can also display the User's Logo when the projector is not receiving an input signal.

You can select a photo, graphic, or company logo as the user's logo, which is useful in identifying the projector's owner to help deter theft. You can also set password protect for the User's Logo so that it cannot be changed.



Once a User's Logo has been saved, the logo cannot be returned to the factory default.

- 1 Project the image you want to save as the User's Logo, and then press the [Menu] button.

☛ "Using the Configuration Menu" p.92

- 2 Select **User's Logo** from **Extended**.



- When **User's Logo Protection** from **Password Protection** is set to **On**, a message is displayed and the User's Logo cannot be changed. Perform operations after setting **User's Logo Protection** to **Off**.

☛ "Kinds of Password Protection" p.73

- If you select Keystone or Aspect while performing **User's Logo**, the function currently being executed is temporarily paused.

- 3 When the message "Choose this image as the User's Logo?" is displayed, select **Yes**.



When you press the [↵] button, the screen size may change depending on the signal to match the actual resolution of the image signal.

- 4 Move the box to select the part of the image to use as the User's Logo.

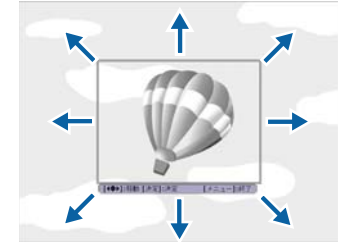
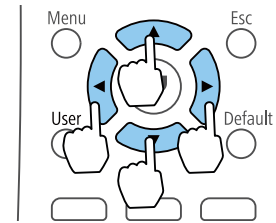

You can save at 400x300 dots in size.

- 5 When you press the [↵] button and the message "Select this image?" is displayed, select **Yes**.

- 6 Select the zoom factor from the zoom setting screen.

- 7 When the message "Do you save this image as the User Pattern?" is displayed, select **Yes**.

The image is saved. After the image has been saved, the message "Completed." is displayed.



When a User's Logo is saved, the previous User's Logo is erased.

You can schedule turning the projector power on/off and switching the input source, as events in the schedule. Registered events are executed automatically at the specified time on the specified dates or weekly. You can register up to 30 **Schedule** events.

Warning

Do not place flammable objects in front of the lens. If you schedule the projector to turn on automatically, flammable objects in front of the lens could catch on a fire.



- If the **Schedule Protection** password is set to **On**, on the **Password Protection** screen, you need to set it to **Off** first.
- Light Source Calibration does not start if the projector is used continuously for more than 24 hours, or regularly turned off by shutting off the power outlet. Execute with **Run Now**, or set **Light Source Calibration** using the scheduling function to adjust the light source periodically.
 - ☛ **Reset - Light Source Calibration** [p.113](#)
- If you do not want to start Light Source Calibration automatically, set **Run Periodically** to **Off**.
 - ☛ **Reset - Light Source Calibration - Run Periodically** [p.113](#)
- When Light Source Calibration is enabled, turn on the projector at least 20 minutes before the event.
- Execute Light Source Calibration to correct the white balance in the light source.

1 Press the [Menu] button while projecting.
☛ "Using the Configuration Menu" [p.92](#)

2 Select **Schedule Settings** from **Extended**, and then press [↵].

3 Select **Add New**, and then press the [↵] button.

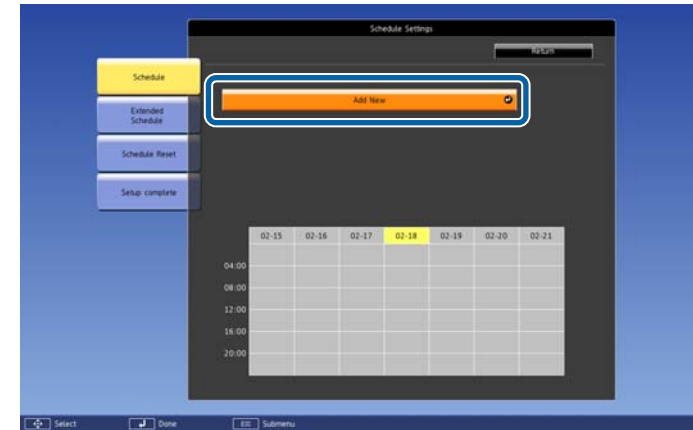

4 Set the schedule.







Submenu Name	Function
Event Settings	Select an operation of the projector when the event is executed. Select No Change for items that you do not want to change when the event occurs. You can set the following item operations. Schedule <ul style="list-style-type: none"> • Power • Source • Light Source Mode • A/V Mute • Light Source Calibration • Volume
Date / Time Settings	Set the date, day of the week, and time to execute the event. You can set up to four weeks later. Use the soft keyboard to enter the date and time. ☛ "Soft keyboard operations" p.103

5 Select **Save**, and then press the [↵] button.

To register additional events, repeat steps 3 to 5.

The registered event is displayed on the screen. The event status and time are indicated by icons or indicators.



- ①  : valid schedule
-  : regular schedule
-  : invalid schedule
- ② The date currently selected (highlighted in yellow)
- ③  : one time schedule
-  : regular schedule
-  : standby schedule (turns communication on or off during standby)
-  : invalid schedule

6 To edit a scheduled event, select the schedule and press **ESC**.

7 Select an option from the menu displayed.

- **On** or **Off** lets you enable or disable the selected event.
- **Edit** lets you change the event details or date and time.
- **Clear** lets you remove the scheduled event from a list.

8 Select **Complete**, and then select **Yes** to finish saving.
To delete all scheduled events, select **Schedule Reset**.

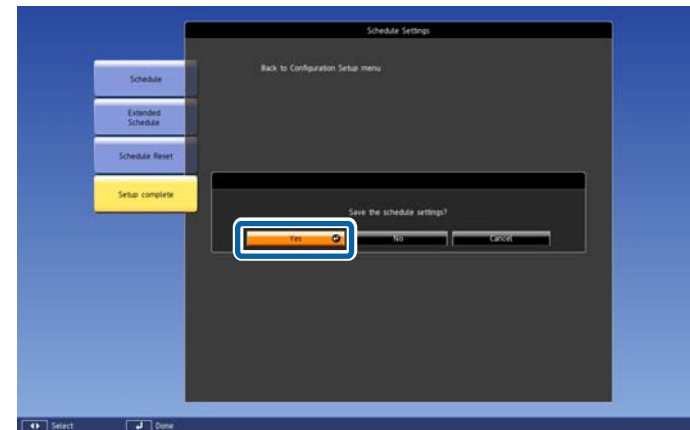

The password prevents anyone from using the projector without first entering a password. It also prevents settings from being changed such as the screen displayed at startup.

This acts as an anti-theft function as the projector cannot be used even if it is stolen, and you can limit who can use the projector.

Kinds of Password Protection

You can set up the following types of password security using one shared password:

- **Power On Protection** password prevents anyone from using the projector without first entering a password. When plugging the power cord and turning on the projector at first time, you must enter the correct password. This also applies to Direct Power On and Auto Power On.
- **User's Logo Protection** password prevents anyone from changing the custom screen displayed when the projector turns on, or when no signal is being input. The custom screen discourages theft by identifying the projector's owner.
- **Network Protection** password prevents anyone from changing the projector's **Network** settings.
- The **Schedule Protection** password prevents anyone from changing the projector's schedule settings.

Setting a Password

To use password security, you must set a password.



The default password is set to "0000". Change this to your own password.

- 1 Hold down the [Effect] button on the remote control for about 5 seconds.

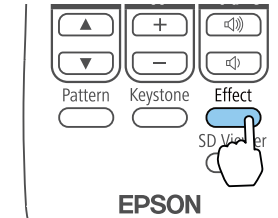

The Password Protection setting menu is displayed.



If Password Protection is already activated, you must enter the correct password to display the Password Protection setting menu.

- 2 Select **Password**, and then press the [**↵**] button.

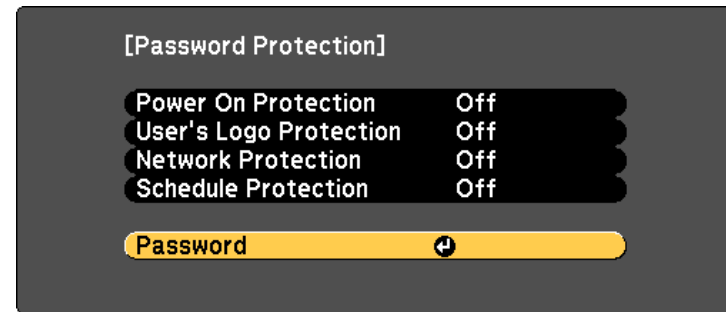

[**↵**]:Select [**↵**]:Enter

[Menu]:Exit

You see the prompt "Change the password?".

- 3 Select **Yes**, and then press the [**↵**] button.



If you select **No**, the Password Protection setting menu is displayed again.

- 4** Press the numeric buttons to set a four digit password.

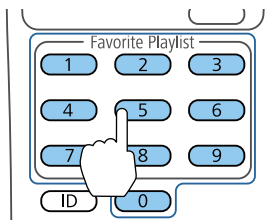

The password displays as "****" as it is entered. A confirmation prompt is displayed when you enter the fourth digit.

- 5** Enter the password again.
"Password accepted. " is displayed. If you enter the password incorrectly, a message is displayed prompting you to re-enter the password.
- 6** Press [Esc] to return to the menu.
- 7** Make a note of the password and keep it in a safe place.

Selecting Password Security Types

After setting a password, you see this menu, allowing you to select the password security types you want to use.

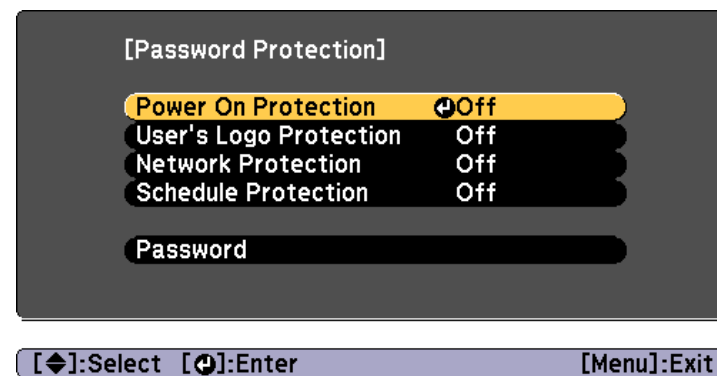

If you do not see this menu, hold down the [Effect] button on the remote control for 5 seconds until the menu is displayed.

- To prevent unauthorized use of the projector, select **On** as the **Power On Protection** setting.
- To prevent changes to the User's Logo screen or related display settings, select **On** as the **User's Logo Protection** setting.
- To prevent changes to network settings, select **On** as the **Network Protection** setting.
- To prevent changes to the projector's schedule settings, select **On** as the **Schedule Protection** setting.

You can attach the password protect sticker to the projector as an additional theft deterrent.



Make sure you store the remote control in a safe place. If you lose the remote control, you cannot enter the password.

Entering a Password to Use the Projector

When the password screen is displayed, enter the correct password.

[Password]

Enter the password.



See your documentation for more information.

[0-9] :Enter

- 1 Press the numeric buttons to enter the password.

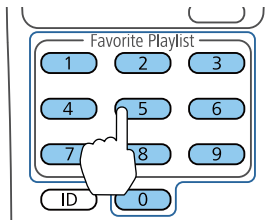

The password screen closes.

- 2 If the password is incorrect, you see a message and a prompt to try again. Enter the correct password to proceed.

Attention

- If you enter the wrong password three times in succession, the message "The projector's operation will be locked." is displayed for approximately five minutes, and the projector switches to standby mode. If this happens, disconnect the power plug from the electrical outlet, reinsert it, and turn the projector back on. The projector displays the password entry screen again so that you can enter the correct password.
- If you have forgotten the password, make a note of the "Request Code: xxxxx" number that appears on the screen, and contact your local dealer or the nearest address provided in the Epson Projector Contact List.
- If you continue to repeat the above operation and input the wrong password 30 times in succession, the message "The projector's operation will be locked. Contact Epson as described in your documentation." is displayed and the projector does not accept any more password entries. Contact your local dealer or the nearest address provided in the Epson Projector Contact List.

☞ [Epson Projector Contact List](#)



Using the Projector on a Network

Follow the instructions in these sections to set up your projector for use on a network.

You can send images to your projector through a wired network. To do this, connect the projector to your network, and then set up your projector and computer for network projection.

After connecting the projector and making network settings, download Epson iProjection (Windows/Mac) from the website and then install it.

Download Epson iProjection from the following website.

<http://www.epson.com>

Epson iProjection software sets up your computer for network projection. You can also project images from multiple computers connected to the network at the same time. See the "Epson iProjection Operation Guide (Windows/Mac)" for instructions.

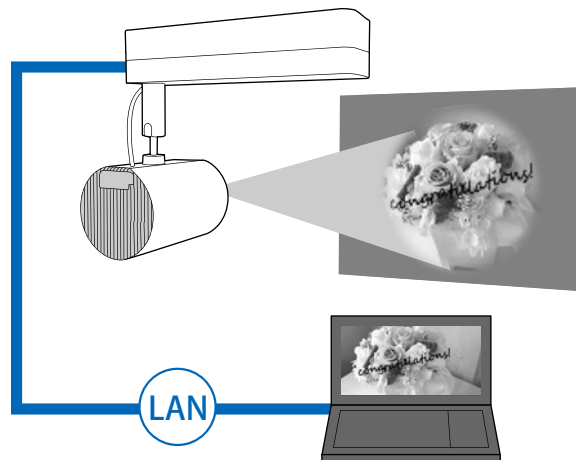

Selecting Wired LAN Settings

Before you can project from computers on your network, you need to select network settings on the projector.



Before making settings, connect the LAN cable to the LAN port on the projector.

☞ "Connecting to Various Devices" p.24

- 1 Press the [Menu] button on the remote control.
- 2 Select **Network**, and then press the [↵] button.

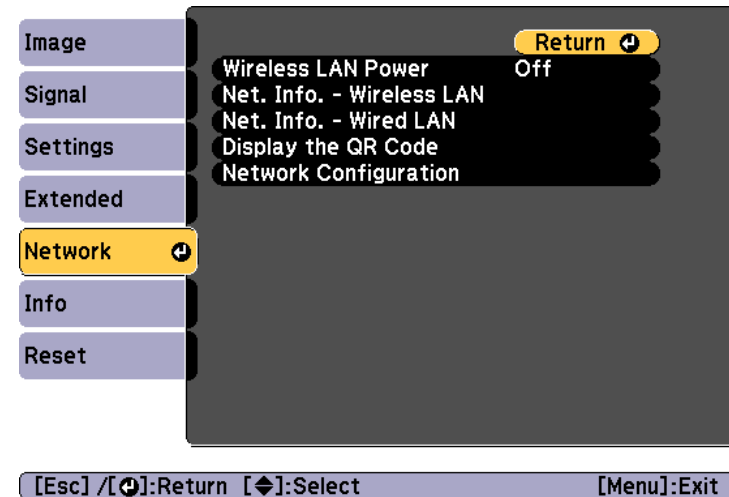

- 3 Select **Network Configuration**, and then press the [↵].

- 4** Select **Basic**, and then press the [↵] button.

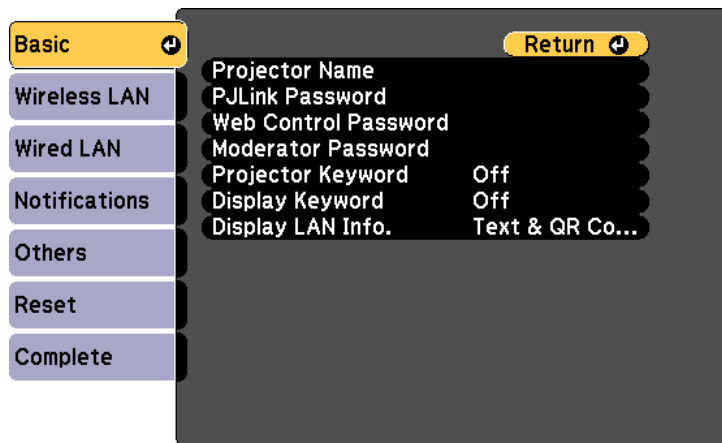

[Esc] / [⏏]:Return [⬇️]:Select

- 5** Select the basic options as necessary.

- **Projector Name:** Enter the projector name used to identify the projector over a network. You can enter up to 16 single-byte alphanumeric characters.
- **PLink Password:** Lets you set a password for using the PLink protocol for projector control. You can enter up to 32 single-byte alphanumeric characters.
- **Web Control Password:** Allows you to set a password for accessing the projector using Epson iProjection or Epson Web Control. You can enter up to 8 single-byte alphanumeric characters. (The user name is **EPSONWEB**; the default password is **admin**.)
- **Moderator Password:** Lets you set an authentication password when connecting to the projector as a moderator using Epson iProjection. Enter four digits for the password. (There is no default password.)

- **Projector Keyword:** Lets you turn on a security password to prevent access to the projector by anyone not in the room with it. You must enter a displayed keyword using Epson iProjection to project images and send or receive data.
- **Display Keyword:** Lets you display a projector keyword on the projection screen when connecting to the projector using Epson iProjection.
- **Display LAN Info.** lets you set the display format for the projector's network information.



Use the displayed keyboard to enter the name, passwords and keyword. Press the [▲][▼][◀][▶] buttons on the remote control to highlight characters, and press [↵] to select them.

- 6** Select **Wired LAN**, and then press the [↵] button.

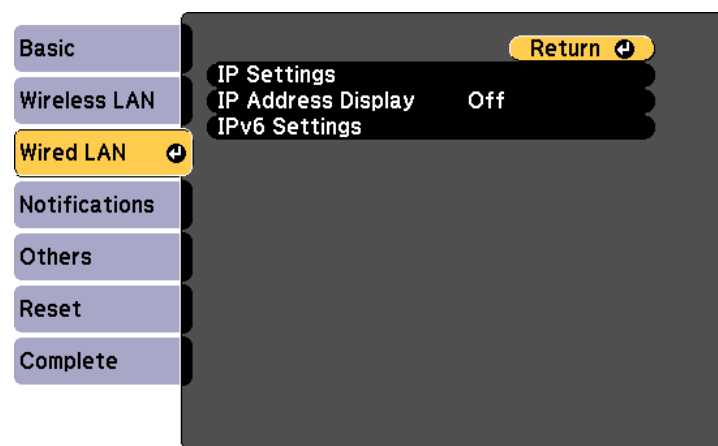

[Esc] / [⏏]:Return [⬇️]:Select

- 7** Assign the IP settings for your network as necessary.

- If your network assigns addresses automatically, select **IP Settings** to set the **DHCP** setting to **On**.

- If you must set addresses manually, select **IP Settings** to set the **DHCP** setting to **Off**, and then enter the projector's **IP Address**, **Subnet Mask**, and **Gateway Address** as necessary.
- If you want to connect the projector to the network using IPv6, select **IPv6 Settings**.

☞ "Wired LAN menu" p.108



Press the [▲][▼][◀][▶] buttons on the remote control, and then select the number you want to enter on the soft keyboard displayed. Press the [↵] button to confirm.

- 8** To prevent the IP address from being displayed on the LAN standby screen, set the **IP Address Display** setting to **Off**.
- 9** If you have finished making settings, select **Complete**. Follow the on-screen instructions to save the settings and close the menu.
- 10** Press the [LAN] button on the remote control.
The wired network settings complete when you see the correct IP address on the LAN standby screen.

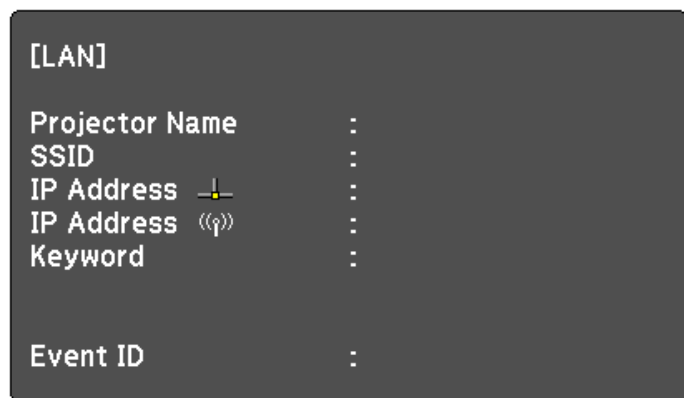

You can send images to your projector through a wireless network.



You can connect the projector to your wireless network by configuring the connection manually using the projector's **Network** menus.

Set the projector's time before configuring the **Network** menu. If the time is not set, the wireless LAN may not be configured correctly.

☛ "Setting the Date and Time" [p.30](#)

After making settings on the **Network** menu, download the necessary network software from the Web site and install it.

- Epson iProjection (Windows/Mac) software allows you to hold interactive meetings by projecting the computer screens of users over a network. See the "Epson iProjection Operation Guide (Windows/Mac)" for instructions.
- Epson iProjection (iOS/Android) app allows you to project from iOS or Android mobile devices.
You can download Epson iProjection (iOS/Android) for free from the App Store or Google Play. Any fees incurred when communicating with the App Store or Google Play are the responsibility of the customer.

- Epson iProjection (Chromebook) allows you to project images from a Chromebook.

You can download Epson iProjection (Chromebook) for free from the Chrome Web Store. Any fees incurred when communicating with the Chrome Web Store are the responsibility of the customer.

Selecting Wireless Network Settings Manually

Before you can project from your wireless network, you need to select network settings for the projector.

- 1 Press the [Menu] button on the remote control.
- 2 Select **Network**, and then press the [**↵**] button.

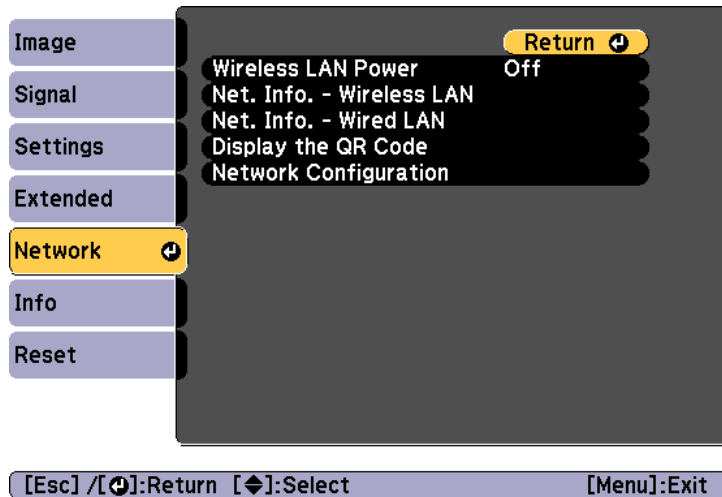

- 3 Select **On** as the **Wireless LAN Power** setting.

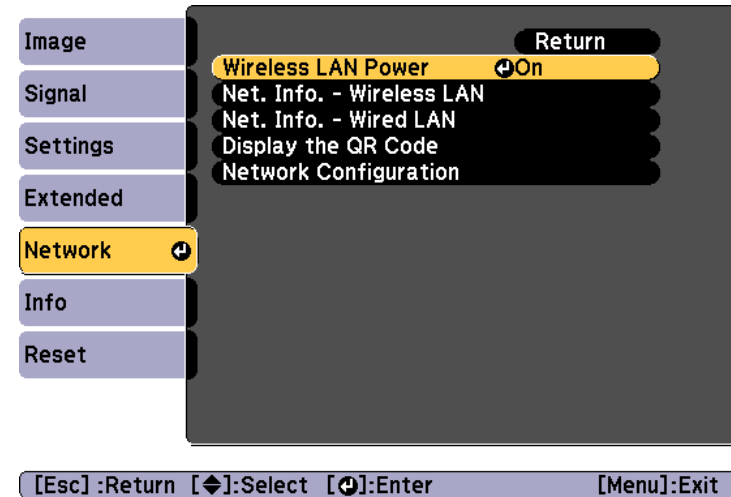

- 4 Select **Network Configuration**, and then press the [**↵**].

- 5 Select **Basic**, and then press the [**↵**] button.

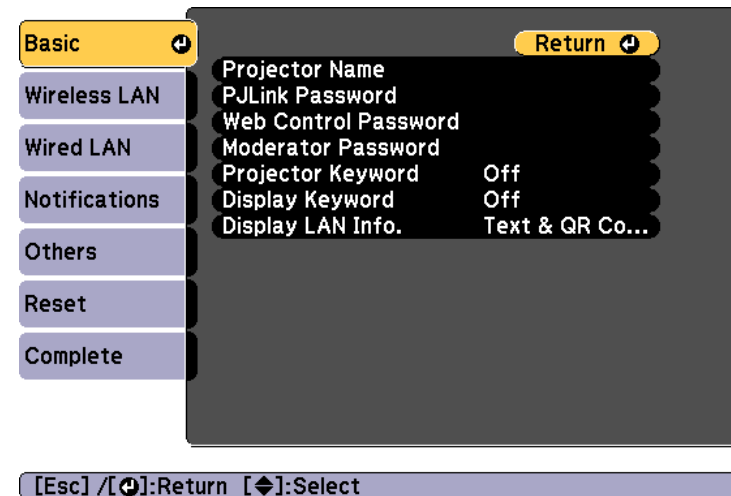

6 Select the basic options as necessary.

- **Projector Name:** Enter the projector name used to identify the projector over a network. You can enter up to 16 single-byte alphanumeric characters.
- **PJLink Password:** Lets you set a password for using the PJLink protocol for projector control. You can enter up to 32 single-byte alphanumeric characters.
- **Web Control Password:** Allows you to set a password for accessing the projector using Epson iProjection or Epson Web Control. You can enter up to 8 single-byte alphanumeric characters. (The user name is **EPSONWEB**; the default password is **admin**.)
- **Moderator Password:** Lets you set an authentication password when connecting to the projector as a moderator using Epson iProjection. Enter four digits for the password. (There is no default password.)
- **Projector Keyword:** Lets you turn on a security password to prevent access to the projector by anyone not in the room with it. Set Projector Keyword to **On** when using thumbnail display or the send function between the projector and connected devices.
- **Display Keyword:** Lets you display a projector keyword on the projection screen when connecting to the projector using Epson iProjection.
- **Display LAN Info.** lets you set the display format for the projector's network information.



Use the displayed keyboard to enter the name and password. Press the [▲][▼][◀][▶] buttons on the remote control to highlight characters, and press [↵] to select them.

7 Select **Wireless LAN**, and then press the [↵] button.

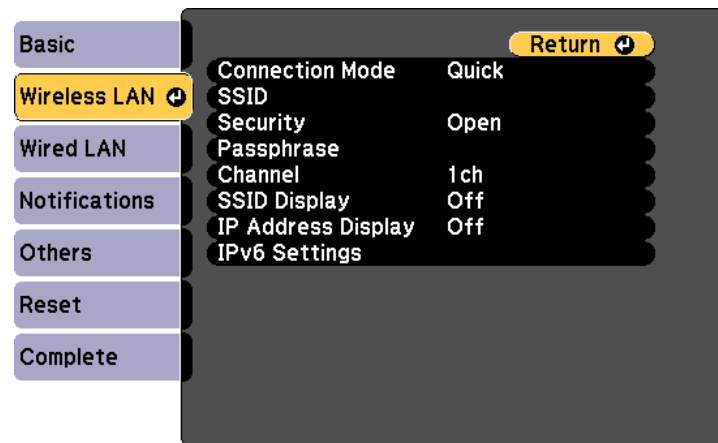

[Esc] / [⏏]:Return [↵]:Select

8 Select the **Connection Mode** setting.

- **Quick** lets you connect to multiple smartphones, tablets, or computers directly using wireless communication.
- **Advanced:** Lets you connect to a smartphone, tablet, or computer over a wireless LAN access point.

9 If you selected the **Advanced** connection mode, select **Search Access Point** to select the access point you want to connect to.



If you need to assign the SSID manually, select **SSID** to enter the SSID.

10 For the **Advanced** connection mode, assign the IP settings for your network as necessary.

- If your network assigns addresses automatically, select **IP Settings** to set the **DHCP** setting to **On**.

- If you must set addresses manually, select **IP Settings** to set the **DHCP** setting to **Off**, and then enter the projector's **IP Address**, **Subnet Mask**, and **Gateway Address** as necessary.
- If you want to connect the projector to the network using IPv6, select **IPv6 Settings**.
 - ☛ "Wireless LAN menu" p.105

11 To prevent the SSID or IP address from being displayed on the LAN standby screen, set the **SSID Display** setting or the **IP Address Display** setting to **Off**.

12 If you have finished making settings, select **Complete**. Follow the on-screen instructions to save the settings and close the menu.

13 Press the [LAN] button on the remote control.

The wired network settings complete when you see the correct IP address on the LAN standby screen.

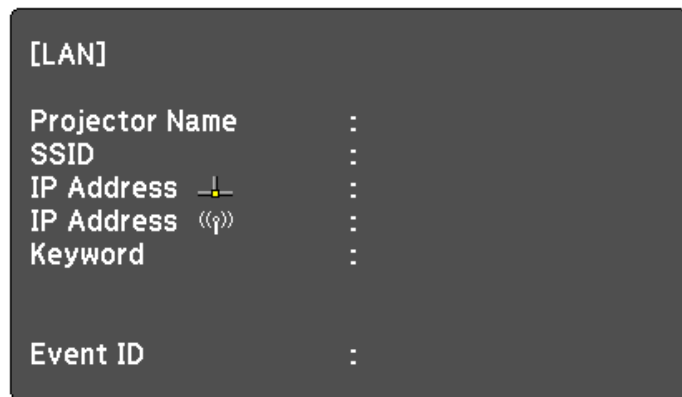

When you have finished making wireless settings for your projector, you need to select the wireless network on your computer. Then start the network software to send images to your projector through a wireless network.

Selecting Wireless Network Settings in Windows

Before connecting to the projector, select the correct wireless network on your computer.

- 1** To access your wireless utility software, double-click the network icon on the Windows taskbar.
- 2** When connecting in Advanced, select the network name (SSID) of the network the projector is connecting to.
- 3** Click **Connect**.

Selecting Wireless Network Settings in Mac

Before connecting to the projector, select the correct wireless network on your computer.

- 1** Click the Wi-Fi icon on the menu bar at the top of the screen.
- 2** When connecting in Advanced connection mode, make sure Wi-Fi is turned on and select the network name (SSID) of the network the projector is connecting to.

Setting Up Wireless Network Security

You can set up security for your projector to use on a wireless network. Set up one of the following security options to match the settings used on your network:

- WPA2-PSK security
- WPA2-EAP security *
- WPA/WPA2-PSK security *
- WPA/WPA2-EAP security *

*Only available for Advanced connection mode.



Contact your network administrator for guidance on entering the correct information.

- 1 Make sure your digital certificate file is compatible with the projector and stored in the root directory of the SD card.
 - ☛ "Supported Client and CA Certificates" [p.86](#)
- 2 Press the [Menu] button on the remote control.
- 3 Select **Network**, and then press the [**↵**] button.
- 4 Select **Network Configuration**, and then press the [**↵**].

- 5 Select **Wireless LAN**, and then press the [**↵**] button.

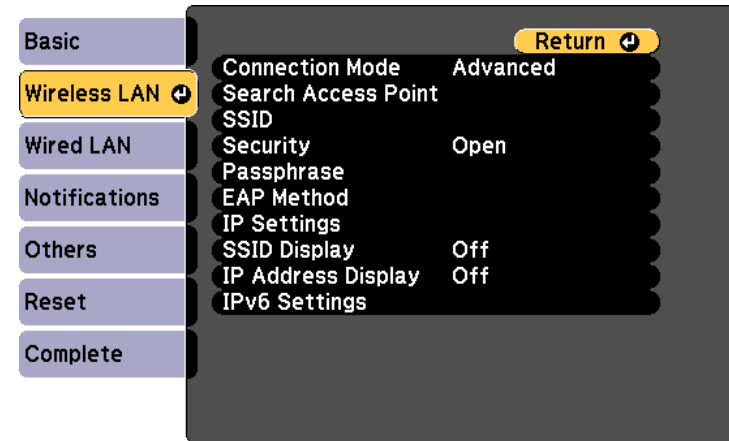

[Esc] / [↵]:Return [↵]:Select

- 6 Select **Security**, and then press the [**↵**] button.

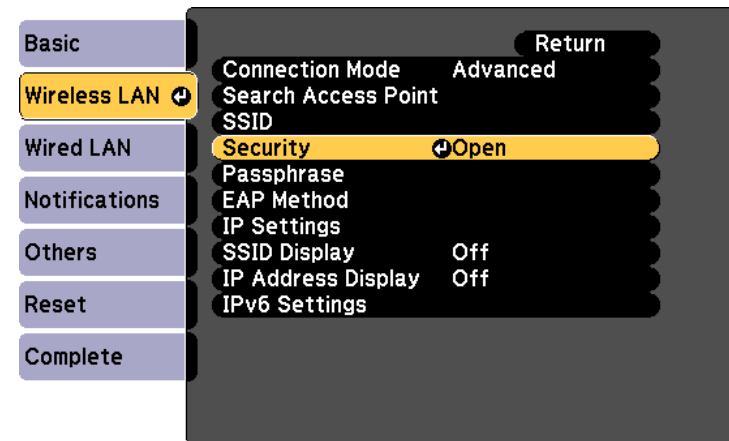

[Esc] :Return [↵]:Select [↵]:Enter

- 7 Select the security settings to match your network settings.

- WPA2-PSK, WPA/WPA2-PSK:

Select **Complete**. Follow the on-screen instructions to save the settings and close the menu.

- WPA2-EAP, WPA/WPA2-EAP:

Select **EAP Method**, and then press the [**↵**] button.

8 Select the protocol for authentication as the **EAP Type** setting.

9 Select a certificate type, and then press the [**↵**] button.

- **Client Certificate** for the **PEAP-TLS** or **EAP-TLS** type
- **CA certificate** for the **PEAP**, **PEAP-TLS**, **EAP-TLS**, or **EAP-FAST** type



You can also register the digital certificates from your Web browser. However, be sure to register just once or the certificate may not install correctly.

☞ "Setting a certificate using a Web browser" p.89

10 Select **Register**, and then press the [**↵**] button.

11 Insert the SD card into the projector's SD card slot.

12 Press the [**↵**] button to display the certificate list.

13 Select the certificate to import using the displayed list.

A message is displayed prompting you to enter the password for the certificate.

14 Enter the password, and then press the [**↵**] button.

The certificate is imported and a completion message appears.

15 Select your EAP settings as necessary.

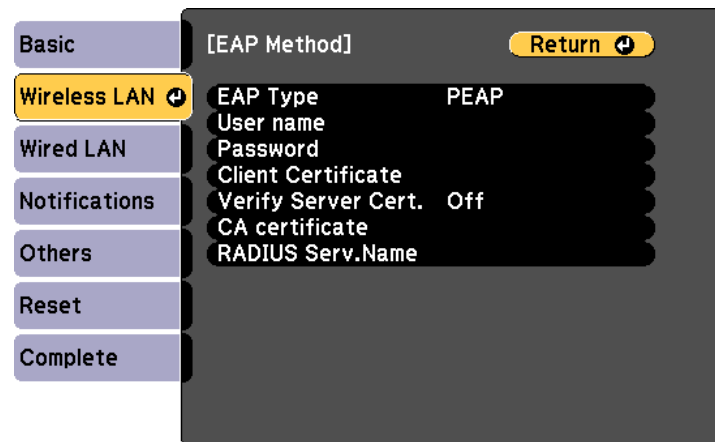

[Esc] / [⏪]:Return [⏩]:Select

- **User Name:** Enter the user name. You can enter up to 64 single-byte alphanumeric characters. When entering more than 32 characters, use your Web browser to enter the text. When importing a client certificate, the name the certificate was issued to is automatically set.
- **Password:** Enter the password used for authentication in **PEAP**, **EAP-FAST**, and **LEAP**. You can enter up to 64 single-byte alphanumeric characters. When entering more than 32 characters, use your Web browser to enter the text.
- **Verify Server Cert.** lets you select whether or not to verify the server certificate when a CA certificate has been set.
- **RADIUS Serv.Name** lets you enter the server name to be verified.

16 If you have finished making settings, select **Complete**. Follow the on-screen instructions to save the settings and close the menu.

Supported Client and CA Certificates

You can register these types of digital certificates.

Client Certificate (PEAP-TLS/EAP-TLS)

Item	Explanation
Format	PKCS#12
Extension	PFX, P12
Encryption	RSA
Hashes	MD5/SHA-1/SHA-256/SHA-384/SHA-512
Key length	512/1024/2048/4096 bit
Password *	You need to setup a password. Up to 32 single-byte alphanumeric characters

CA Certificate (PEAP/PEAP-TLS/EAP-TLS/EAP-FAST)

Item	Explanation
Format	X509v3
Extension	DER/CER/PEM
Encryption	RSA
Hashes	MD5/SHA-1/SHA-256/SHA-384/SHA-512
Key length	512/1024/2048/4096 bit
Encoding	BASE64/Binary

* You can set a password using up to 64 alphanumeric characters. When entering more than 32 characters, use your Web browser to enter the text.

☛ "Operating Using Epson Web Control (Web Browser)" [p.40](#)

Using a QR Code to Connect a Mobile Device

After making the wireless network settings for your projector, you can display a QR code on the screen and use it to connect a mobile device using the Epson iProjection (iOS/Android) app.



- Make sure you have installed the latest version of Epson iProjection on your device (Epson iProjection V1.3.0 or later supports this feature).
- You can download Epson iProjection for free from the App Store or Google Play. Any fees incurred when communicating with the App Store or Google Play are the responsibility of the customer.
- When using Epson iProjection in Quick, we recommend making security settings.

1

Select **Display the QR Code** from the **Network** menu.

The QR code is displayed on the projected surface.



- If you do not see the QR code, set the **Display LAN Info.** setting to **Text & QR Code** in the projector's Network menu.
☛ **Network - Network Configuration - Display LAN Info. p.104**
- To hide the QR code, press the [Esc] button.
- When the QR code is hidden, press the [**↵**] button to display the code.

2

Start Epson iProjection on your mobile device.

3

Read the projected QR code using Epson iProjection to connect it to the projector.



To correctly read the QR code, make sure you face the screen squarely and closely enough so that the projected code fits into the guide of the mobile device's QR code reader. If you are too far from the screen, the code may not be read.

When a connection is established, select **Contents** menu from , and then select the file you want to project.

You can use the HTTPS protocol to increase security between the projector and a Web browser communicating with it. To do this, you need to create a server certificate, install it on the projector, and set **Secure HTTP** to **On** to verify the reliability of the Web browser.

☛ **Network - Network Configuration - Others - Secure HTTP** [p.110](#)

Even if you do not install a server certificate, the projector automatically creates a self-signed certificate and allows communication. However, because the self-signed certificate cannot verify reliability from a Web browser, you see a warning about the server's reliability when you access the projector from a Web browser. This warning does not prevent communication.

Importing a Web Server Certificate Using the Menus

You can create a Web server certificate and import it using the projector menus and an SD card.



You can also register the digital certificates from your Web browser. However, be sure to register just once or the certificate may not install correctly.

☛ "Setting a certificate using a Web browser" [p.89](#)

- 1** Make sure your digital certificate file is compatible with the projector and stored in the root directory of the SD card.
☛ "Supported Web Server Certificates" [p.89](#)
- 2** Press the [Menu] button on the remote control.
- 3** Select **Network**, and then press the [↵] button.
- 4** Select **Network Configuration**, and then press the [↵].

- 5 Select the **Others** menu, and then press the [↵] button.

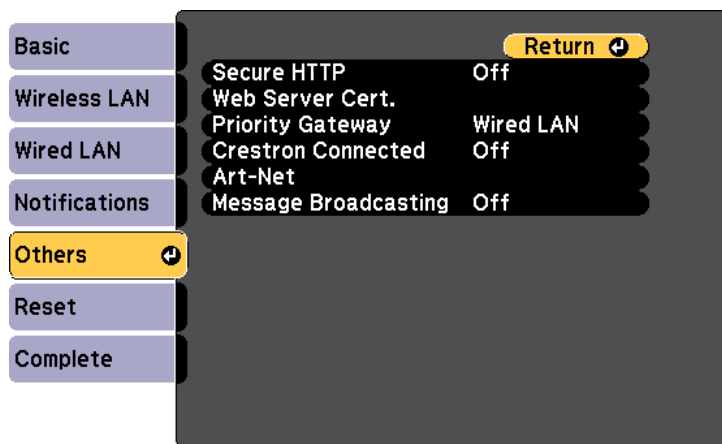

[Esc] / [⏏]:Return [⏏]:Select

- 6 Select **On** as the **Secure HTTP** setting.
- 7 Select **Web Server Cert.**, and then press the [↵] button.
- 8 Select **Register**, and then press the [↵] button.
- 9 Insert the SD card into the projector's SD card slot.
- 10 Press the [↵] button to display the certificate list.
- 11 Select the certificate to import using the displayed list.
A message is displayed prompting you to enter the password for the certificate.
- 12 Enter the password, and then press the [↵] button.
The certificate is imported and a completion message appears.

Supported Web Server Certificates

You can register these types of digital certificates.

Web Server Certificate (Secure HTTP)

Item	Explanation
Format	PKCS#12
Extension	PFX, P12
Encryption	RSA
Hashes	SHA-256
Key length	2048 bit
Common Name	Projector Name
Organization	SEIKO EPSON CORP.
Password *	You need to setup a password. Up to 32 single-byte alphanumeric characters

* You can set a password using up to 64 alphanumeric characters. When entering more than 32 characters, use your Web browser to enter the text.
 "Operating Using Epson Web Control (Web Browser)" [p.40](#)

Setting a certificate using a Web browser

You can use an electronic certificate as the projector's security settings.



You can install the electronic certificate from the projector's Network menu. However, be sure to register just once or the certificate may not install correctly.

 "Setting Up Wireless Network Security" [p.84](#)

- 1 Prepare a certificate that is supported by the projector.

- 2 Make sure the projector is turned on.
- 3 Launch the Web browser on the computer or mobile device connected to the network.
- 4 Enter the IP address of the projector in the address input box of the browser to connect to the Epson Web Control screen.
The Home screen is displayed.

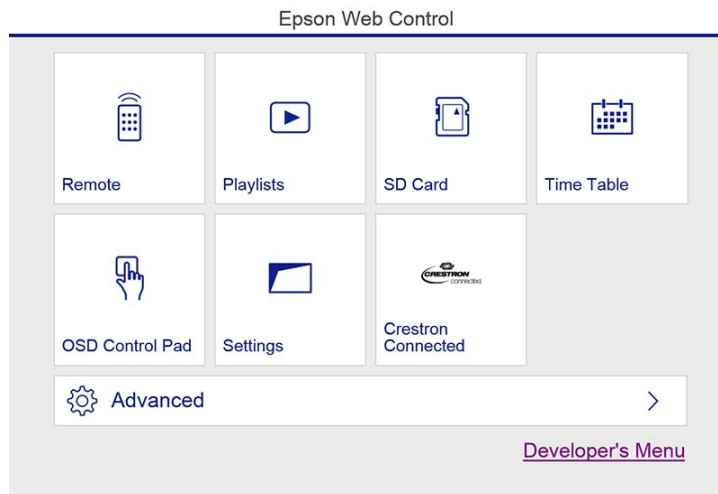

- 5 Select **Advanced**.



You need to login to display the Advanced screen. When the login screen is displayed, enter your user name and password. (The user name is EPSONWEB; the default password is admin.)

Click the menu icon at the top left to display the menu.

- 6 Select **Certificate** from **Network**.

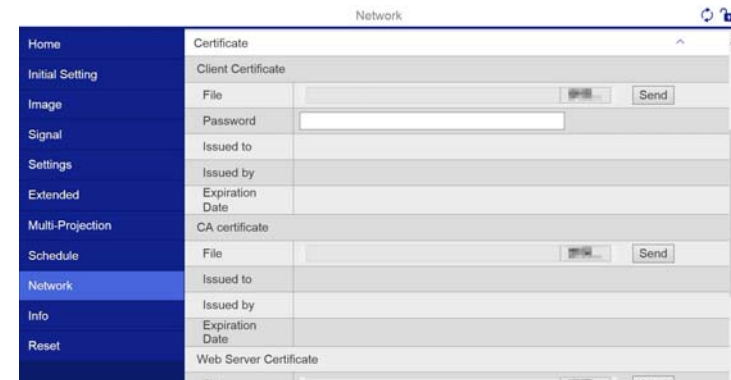

- 7 Click the button to browse a file, and then select the certificate file.
- 8 Enter the password in the **Password** box, and then click **Send**.
- 9 When the settings are complete, click the **Apply**.



Configuration Menu

This chapter explains how to use the Configuration menu and its functions.

This section explains how to use the Configuration menu.

Check the guide under the menu for the available buttons and their operations.

1 Display the Configuration menu screen.

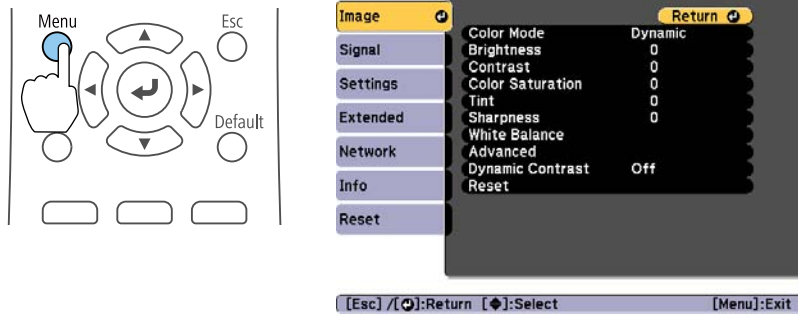

2 Select a top menu item.

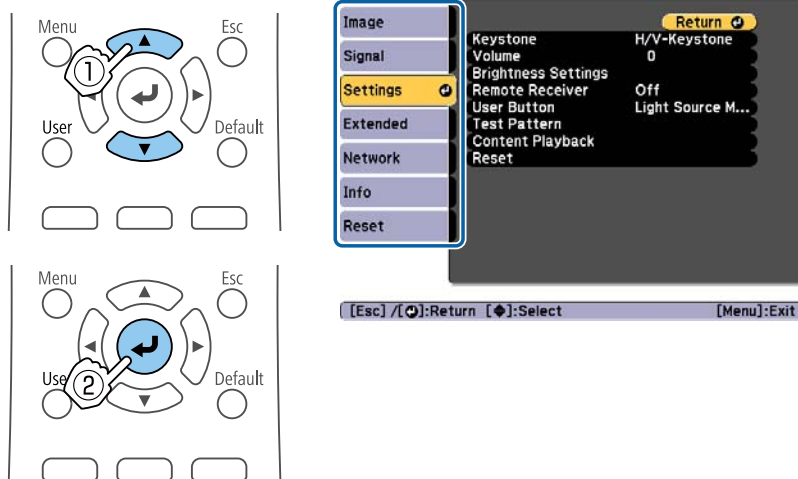

3 Select a submenu item.

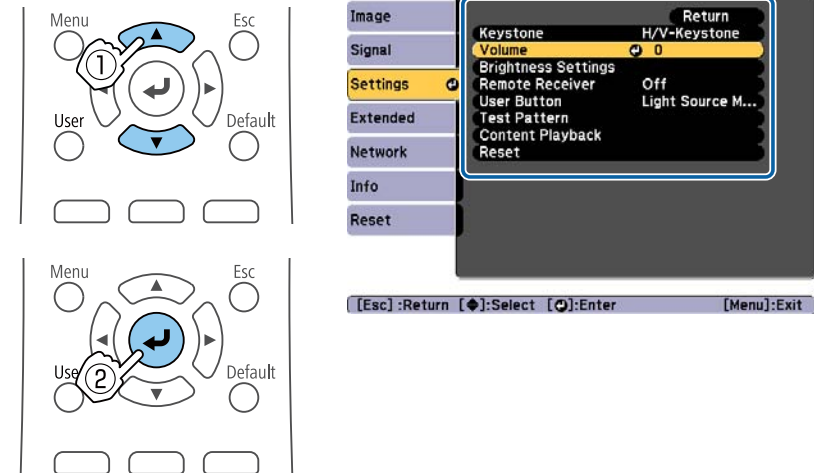

4 Change settings.

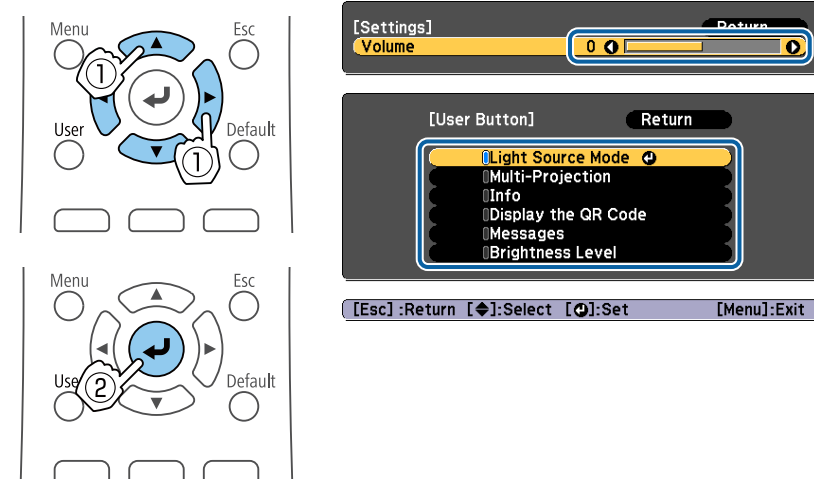

When **Default: Reset** is displayed on the guide under the menu, pressing the [Default] button on the remote control returns the settings being adjusted to their default values.



- 5 Press the [Menu] button to finish making settings.

Configuration Menu Table

Settable items vary depending on the model being used and the image signal and source being projected.

Top Menu Name	Submenu Name	Items or Setting Values
Image menu ☛ p.96	Color Mode	Dynamic, Normal
	Brightness	0 to 100
	Contrast	0 to 100
	Color Saturation	0 to 100
	Tint	0 to 100
	Sharpness	0 to 20
	White Balance	Color Temp., Custom
	Advanced	Gamma
Signal menu ☛ p.97	Aspect	Auto, Normal, 4:3, 16:9, Full, Zoom, Native
	Advanced	HDMI Video Range
	Scale	Scale, Scale Mode, Scale Vertically, Scale Horizontally, Clip Adjustment, Clip Range
Settings menu ☛ p.98	Keystone	H/V-Keystone, Quick Corner
	Volume	0 to 20
	Brightness Settings	Light Source Mode, Brightness Level
	Remote Receiver	On, Off
	User Button	Light Source Mode, Multi-Projection, Info, Display the QR Code, Messages, Brightness Level

Top Menu Name	Submenu Name	Items or Setting Values
	Test Pattern	Standard, Cross-hatching, Cross-hatching R, Cross-hatching G, Cross-hatching B, Color Bars V, Color Bars H, Grayscale, Gray Bars V, Gray Bars H, Checkerboard 1, Checkerboard 2, White, Black, Aspect Frame
	Content Playback	Overlay Effect, SD Viewer
Extended menu ☛ p.99	Display	Messages, Startup Screen, Standby Confirmation, Color Uniformity
	User's Logo	-
	Projection	Front, Front/Ceiling, Rear, and Rear/Ceiling
	Operation	Direct Power On, High Altitude Mode, Auto Power On, Indicators, Startup Source, HDMI EQ Setting, Date & Time
	Standby Mode	Standby Mode, Port
	Multi-Projection	Multi-Projection, Projector ID, Color Mode, Color Uniformity, Edge Blending, Scale, Brightness Settings, Color Matching, Reset
	Schedule Settings	-
	Language	27 languages
Network menu ☛ p.102	Wireless LAN Power	On, Off
	Net. Info. - Wireless LAN	Connection Mode, Wireless LAN Sys., Antenna Level, Projector Name, SSID, DHCP, IP Address, Subnet Mask, Gateway Address, MAC Address, Region Code, IPv6 Address (Manual), IPv6 Address (Auto)

Top Menu Name	Submenu Name	Items or Setting Values
	Net. Info. - Wired LAN	Projector Name, DHCP, IP Address, Subnet Mask, Gateway Address, MAC Address, IPv6 Address (Manual), IPv6 Address (Auto)
	Display the QR Code	-
	Network Configuration	-
Info menu ☛ p.112	Projector Info	Operation Hours, Source, Input Signal, Resolution, Refresh Rate, Sync Info, Status, Serial Number, Event ID
	Light Source Info	Light Source Hours
	Version	Main
Reset Menu ☛ p.113	Refresh Mode	Timer, Start
	Light Source Calibration	Run Now, Run Periodically, Schedule Settings
	Reset All Config	-

Network menu

Top Menu Name	Submenu Name	Items or Setting Values
Basic menu ☛ p.104	Projector Name	-
	PJLink Password	-
	Web Control Password	-
	Moderator Password	-
	Projector Keyword	On, Off
	Display Keyword	On, Off
	Display LAN Info.	Text & QR Code, Text
Wireless LAN menu ☛ p.105	Connection Mode	Quick, Advanced

Top Menu Name	Submenu Name	Items or Setting Values
	Search Access Point	-
	SSID	-
	Security	Open, WPA2-PSK, WPA/WPA2-PSK, WPA2-EAP, WPA/WPA2-EAP
	Passphrase	-
	EAP Method	EAP Type, User Name, Password, Client Certificate, Verify Server Cert., CA certificate, RADIUS Serv.Name
	Channel	1ch, 6ch, and 11ch
	IP Settings	DHCP, IP Address, Subnet Mask, Gateway Address
	SSID Display	On, Off
	IP Address Display	On, Off
	IPv6 Settings	IPv6, Auto Configuration, Use Temporary Address
Wired LAN menu ☛ p.108	IP Settings	DHCP, IP Address, Subnet Mask, Gateway Address
	IP Address Display	On, Off
	IPv6 Settings	IPv6, Auto Configuration, Use Temporary Address
Notifications menu ☛ p.109	Mail Notification	On, Off
	SMTP Server	-
	Port Number	-
	From	-

Top Menu Name	Submenu Name	Items or Setting Values
	Address 1 Setting, Address 2 Setting, Address 3 Setting	Email Address, No Signal, System Error, Laser Error, High Temp Error, Laser Warning, High Temp Warning
	SNMP	On, Off
	Trap IP Address 1, Trap IP Address 2	-
	Community Name	-
	PJLink Notification	On, Off
	Notified IP Address	-
Others menu  p.110	Secure HTTP	On, Off
	Web Server Certificate	-
	Priority Gateway	Wired LAN, Wireless LAN
	Crestron Connected	On, Off
	Art-Net	Art-Net, Net, Sub-Net, Universe, Start Channel
	Message Broadcasting	On, Off

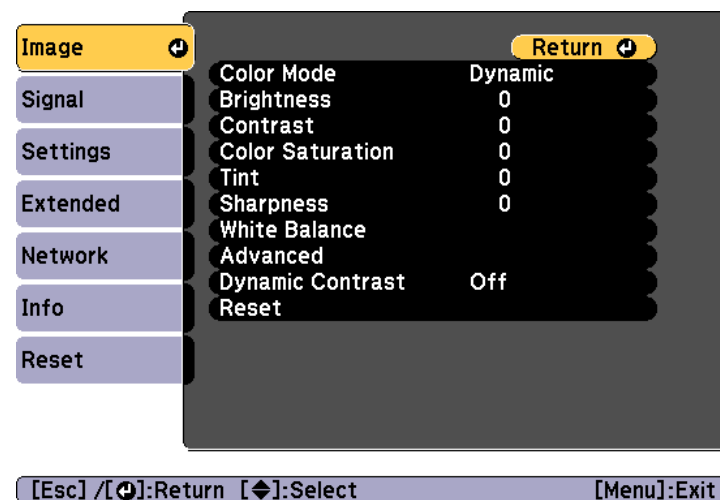

Submenu	Function
Color Mode	You can select the quality of the image to suit your surroundings.  "Selecting the Projection Quality (Selecting Color Mode)" p.52
Brightness	Adjusts the image brightness.
Contrast	Adjusts the difference between light and shade in the images.
Color Saturation	Adjusts the color saturation for the images.
Tint	You can adjust the image tint.
Sharpness	Adjusts the image sharpness.

Image Menu

Settable items vary depending on the image signal and source currently being projected. Setting details are saved for each Color Mode.

Submenu	Function
White Balance	You can adjust the overall tint of the image. Color Temp.*1: You can adjust the overall tint of the image within 14 stages from 3200K to 10000K. The image is tinted blue when a high value is selected and tinted red when a low value is selected. When Color Mode is set to Dynamic , the set Color Temp. may differ from the actual Color Temp. of the light from the projector. Use this menu as a guide. Custom: Adjusts the R (red), G (green), and B (blue) components of the offset and gain.
Advanced	Gamma: You can adjust the coloring by selecting one of the gamma correction values, or referring to the projected graph.
Dynamic Contrast*2	Set to Normal or High Speed to adjust the iris to obtain the optimum light for images being projected. Select High Speed to make faster iris corrections to match the speed of the scene.
Reset	You can reset all adjustment values on the Image menu to their default settings, except for Color Mode . See the following to return all menu items to their default settings. ☛ "Reset Menu" p.113

*1 This cannot be set when **Color Filter** is set to **Warm White** or **Cool White**.

☛ **Settings - Content Playback - Overlay Effect - Color Filter** [p.98](#)

*2 This cannot be set when **Multi-Projection** is set to **On**.

Signal Menu

Settable items vary depending on the image signal and source currently being projected. Setting details are saved for each image signal.

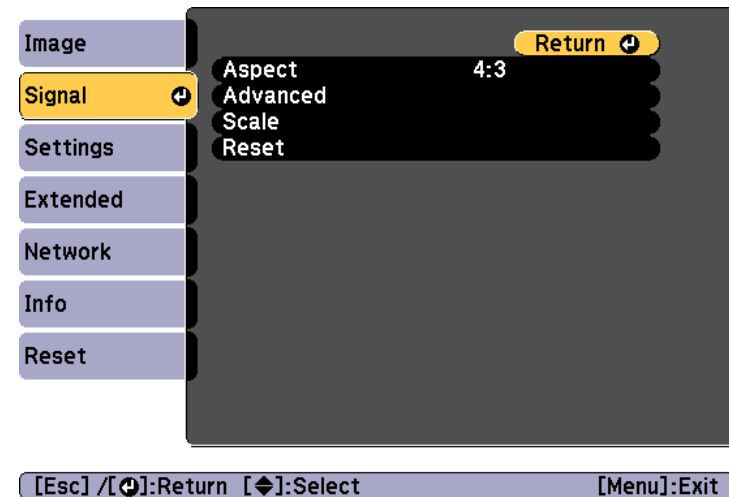

Submenu	Function
Aspect	You can set the Aspect Ratio for projected images. ☛ "Changing the Aspect Ratio of the Projected Image" p.54
Advanced	HDMI Video Range: Select the video range for the input signal from the HDMI port. Set to Expanded if you are concerned about misadjusted black levels or blown out highlights in the image.
Scale	When using multiple projectors to project one image, adjust the range of the image displayed by each projector. ☛ "Displaying a Scaled Image" p.64
Reset	You can reset all adjustment values for the Signal menu to their default settings. See the following to return all menu items to their default settings. ☛ "Reset Menu" p.113

Settings Menu

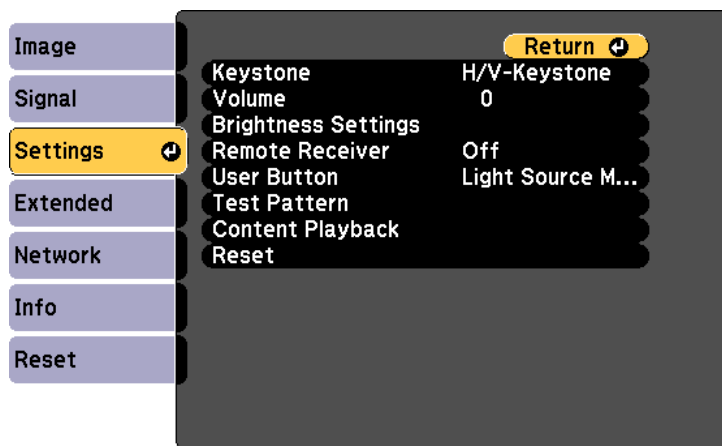

[Esc] / [⏪]:Return [⏩]:Select [Menu]:Exit

Submenu	Function
Keystone	<p>You can correct distortion.</p> <p>☛ "Correcting Distortion in the Projected Image" p.49</p> <ul style="list-style-type: none"> • H/V-Keystone: Adjust V-Keystone and H-Keystone to correct vertical and horizontal keystone distortion. • Quick Corner: Select and correct the four corners of the projected image.
Volume*1	You can adjust the volume. Setting values are saved for each source.

Submenu	Function
Brightness Settings	<p>Light Source Mode: (Only available when Multi-Projection is set to Off) Sets the brightness for the light source.</p> <ul style="list-style-type: none"> • Normal: Select this if you do not want to decrease the brightness. This makes the target usage time approximately 20,000 hours. • Quiet: Select this if you are concerned about the noise made by the fan, This sets the brightness at 50%. This makes the target usage time 20,000 hours. • Extended: Select this to extend the life expectancy of the light source. This sets the brightness at 50%. This makes the target usage time approximately 30,000 hours. • Custom: Select this to set the brightness level within a range of 50 to 100%. <p>Brightness Level: (Only available when Light Source Mode is set to Custom) Sets the brightness for the light source.</p> <p>☛ "Setting the Brightness" p.52</p>
Remote Receiver	<p>You can limit the reception of the operation signal from the remote control.</p> <p>When set to Off, you cannot perform any operations from the remote control. If you want to make operations from the remote control, hold down the [Menu] button on the remote control for at least 15 seconds to reset the setting to its default value.</p>
User Button	<p>Select the item from the Configuration menu that you want to assign to the [User] button on the remote control. You can assign the following items.</p> <p>Light Source Mode, Multi-Projection, Info, Display the QR Code, Messages, Brightness Level</p>
Test Pattern	<p>You can display a test pattern to adjust the projection without connecting other equipment when you set up the projector.</p> <p>☛ "Displaying a Test Pattern" p.48</p>

Submenu	Function
Content Play-back	<p>Overlay Effect*2: Set the filter you want to apply to the image.</p> <p>☛ "Using Overlay Effect" p.45</p> <p>SD Viewer: Allows you to select the playlist you want to play from the SD card.</p> <p>☛ "Playing a Playlist" p.38</p>
Reset	<p>You can reset all adjustment values on the Settings menu to their default settings, except for User Button.</p> <p>See the following to return all menu items to their default settings.</p> <p>☛ "Reset Menu" p.113</p>

*1 This cannot be set when the source is set to Spotlight.

*2 This cannot be set in the following situations.

- When **Edge Blending** is set to **On**.
- When the source is an SD player and a non-writable error has occurred.
- When the source is an SD player and the playlist cannot be played.

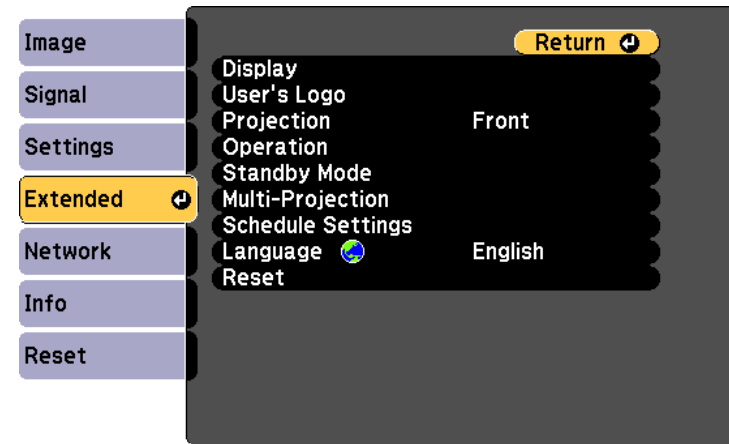

Extended Menu



[Esc] / [⏪]:Return [↵]:Select [Menu]:Exit

Submenu	Function
Display	<p>You can make settings related to the projector's display.</p> <p>Messages: When set to Off, the following items will not be displayed.</p> <p>Item names when the Source, Color Mode, or Aspect is changed, messages when no signal is being input, and warnings such as High Temp Warning.</p> <p>Startup Screen*: Set to On to display the User's Logo when you turn on the projector.</p> <p>Standby Confirmation: If it is set to Off, you can turn off the power simply by pressing the [⏪] button once.</p> <p>Color Uniformity: Adjusts the color tone balance for the whole screen.</p> <p>☛ "Adjusting uneven colors (Color Uniformity)" p.65</p>
User's Logo *	<p>You can change the user's logo that is displayed as a background during Display Background, A/V Mute, and so on.</p> <p>☛ "Saving a User's Logo" p.70</p>

Submenu	Function
Projection	<p>Select from one of the following projection methods depending on how the projector is installed.</p> <p>Front, Front/Ceiling, Rear, and Rear/Ceiling</p> <p>You can change the direction of the image as follows by pressing down the [A/V Mute] button for about five seconds.</p> <p>Front ↔ Front/Ceiling</p> <p>Rear ↔ Rear/Ceiling</p>
Operation	<p>Direct Power On: Set to On to turn on the projector simply by plugging it in to an outlet.</p> <p>When the power cord is plugged in, note that the projector turns on automatically in cases such as a power outage being restored.</p> <p>High Altitude Mode: Set to On when using the projector above an altitude of 1,500 m.</p> <p>Auto Power On: If this is set to HDMI, the projector turns on when a signal is received from the HDMI port, even when the projector is in standby status.</p> <p>Indicators: When set to Off, the projector's indicators are turned off. When set to Off, they turn on when an error or a warning occur, or when standing by or warming up.</p> <p>Startup Source: Set the source you want to input when the projector starts up.</p> <p>HDMI EQ Setting: Change the HDMI reception level according to the video source connected to the HDMI input port. Change this setting if there is noise in the image or if the image is not displayed. If a stick type device is not connected, change the setting to 1.</p> <p>Date & Time: Make system time settings for the projector.</p> <p> "Setting the Date and Time" p.30</p>

Submenu	Function
Standby Mode	<p>Standby Mode: If you set this to Communication On, you can perform network monitoring and control the projector even if the projector is in standby mode.</p> <div style="border: 1px solid black; padding: 5px; margin: 10px 0;"> <p> When monitoring or controlling the projector using wireless LAN, set Connection Mode to Advanced.</p> <p> Network - Wireless LAN - Connection Mode p.105</p> </div> <p>Port: Select the communication port that is enabled when Standby Mode is set to Communication On.</p>

Submenu	Function
Multi-Projection	<p>Make settings when projecting from multiple projectors.</p> <p>☛ "Projecting One Image from Multiple Projectors (Multi-Projection)" p.60</p> <p>Multi-Projection: Set this to On when adjusting multiple images side-by-side.</p> <p>Projector ID: Set the ID from 1 to 9. Off indicates that no ID is set.</p> <p>☛ "Setting the Projector ID" p.61</p> <p>Color Mode: You can select the quality of the image to suit your surroundings.</p> <p>☛ "Selecting the Projection Quality (Selecting Color Mode)" p.52</p> <p>Color Uniformity: Adjusts the color tone balance for the whole screen.</p> <p>☛ "Adjusting uneven colors (Color Uniformity)" p.65</p> <p>Edge Blending: Corrects a border between multiple images to create a seamless screen.</p> <p>☛ "Adjusting the Points Where the Images Overlap (Edge Blending)" p.62</p> <p>Scale: When using multiple projectors to project one image, adjust the range of the image displayed by each projector.</p> <p>☛ "Displaying a Scaled Image" p.64</p> <p>Brightness Settings: Sets the brightness mode of the projector.</p> <p>☛ "Adjusting the Brightness of the Overlay Effect" p.47</p> <p>Color Matching: Corrects the difference between the tint and brightness of each projected image.</p> <p>☛ "Adjusting the tint (Color Matching)" p.67</p> <p>Reset: You can reset all adjustment values for the Multi-Projection menu to their default settings.</p>
Schedule Settings	<p>You can set the projector's schedule so that it performs a specific operation at a pre-scheduled time.</p> <p>☛ "Setting an Event Schedule" p.71</p>
Language	<p>You can set the language for messages and menus.</p>

Submenu	Function
Reset	<p>You can reset all adjustment values for the Extended menu to their default settings. However, the following items are not reset.</p> <p>Color Uniformity, Projection, High Altitude Mode, HDMI EQ Setting, Standby Mode, Port, Multi-Projection, Projector ID, Color Mode, Color Matching, Language</p> <p>See the following to return all menu items to their default settings.</p> <p>☛ "Reset Menu" p.113</p>

* When **User's Logo Protection** is set to **On** in **Password Protection**, you cannot change settings related to user's logo. You can make changes after setting **User's Logo Protection** to **Off**.

☛ "Kinds of Password Protection" [p.73](#)

Network Menu

When **Network Protection** is set to **On** in **Password Protection**, a message is displayed and the network settings cannot be changed. Set **Network Protection** to **Off** and then configure the network.

☛ "Managing Users (Password Protection)" p.73

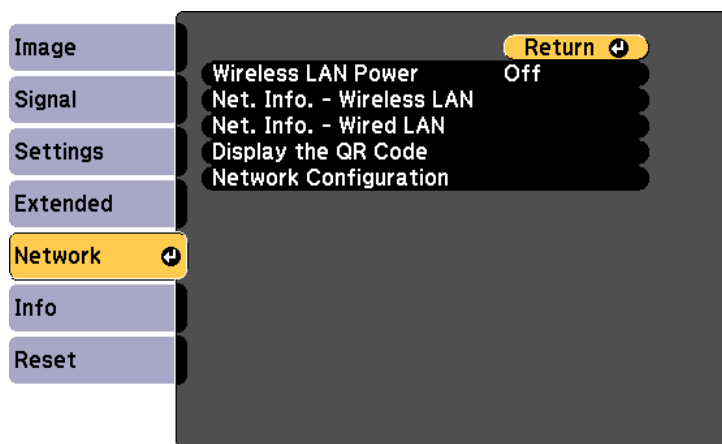

[Esc] / [Return]:Return [Enter]:Select

[Menu]:Exit

Submenu	Function
Wireless LAN Power	Set this to On when connecting the projector and a computer over a wireless LAN. If you do not want to connect over wireless LAN, turn it Off to prevent unauthorized access and so on by others.

Submenu	Function
Net. Info. - Wireless LAN	<p>Displays the following network setting status information.</p> <ul style="list-style-type: none"> • Connection Mode • Wireless LAN Sys. • Antenna Level • Projector Name • SSID • DHCP • IP Address • Subnet Mask • Gateway Address • MAC Address • Region Code <p>When IPv6 is selected, the following information is displayed.</p> <ul style="list-style-type: none"> • IPv6 Address (Manual): IPv6 Address, Prefix Length, Gateway Address • IPv6 Address (Auto): Temporary Address, Link-local Address, Stateless Address, Stateful Address
Net. Info. - Wired LAN	<p>Displays the following network setting status information.</p> <ul style="list-style-type: none"> • Projector Name • DHCP • IP Address • Subnet Mask • Gateway Address • MAC Address • IPv6 Address (Manual): IPv6 Address, Prefix Length, Gateway Address • IPv6 Address (Auto): Temporary Address, Link-local Address, Stateless Address, Stateful Address
Display the QR Code	When connecting iOS or Android devices using Epson iProjection, read the QR code displayed.

Submenu	Function
Network Configuration	The following menus are available for setting Network items. Basic, Wireless LAN, Wired LAN, Notifications, Others, Reset

Notes on operating the Network menu

Selecting from the top menu and sub menus, and changing selected items is the same as making operations from the Configuration menu.

When done, make sure you go to the **Complete** menu, and select **Yes**, **No**, or **Cancel**. When you select **Yes** or **No**, you are returned to the Configuration menu.

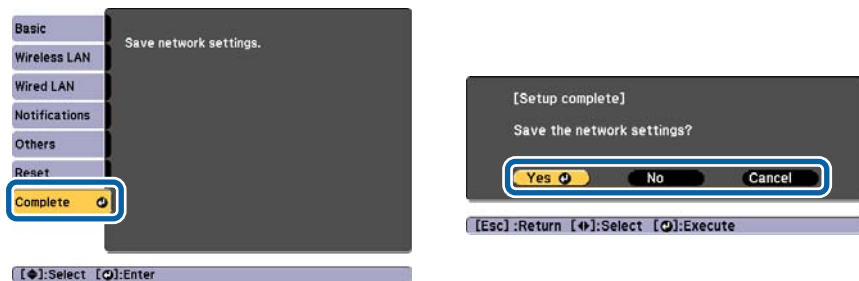

Yes: Saves the settings and exits the Network menu.

No: Does not save the settings and exits the Network menu.

Cancel: Continues displaying the Network menu.

Soft keyboard operations

The Network menu contains items that require input of alphanumerics during setup. In this case, the following software keyboard is displayed. Use the [▲][▼][◀][▶] buttons to move the cursor to the desired key, and then press the [↵] button to enter the selected character. After inputting, press **Finish** on the keyboard to confirm your input. Press **Cancel** on the keyboard to cancel your input.



- Each time the **CAPS** key is selected and the [↵] button is pressed, it sets and changes between upper case and lower case letters.
- Each time the **SYM1/2** key is selected and the [↵] button is pressed, it sets and changes the symbol keys for the section enclosed by the frame.

The following types of character can be entered.

Numbers	0123456789
Letters	ABCDEFGHIJKLMNOPQRSTUVWXYZ abcdefghijklmnopqrstuvwxyz
Symbols	!"#\$%&'()*+,-./:;<=>?@[\\]^_`{ }~

Basic menu

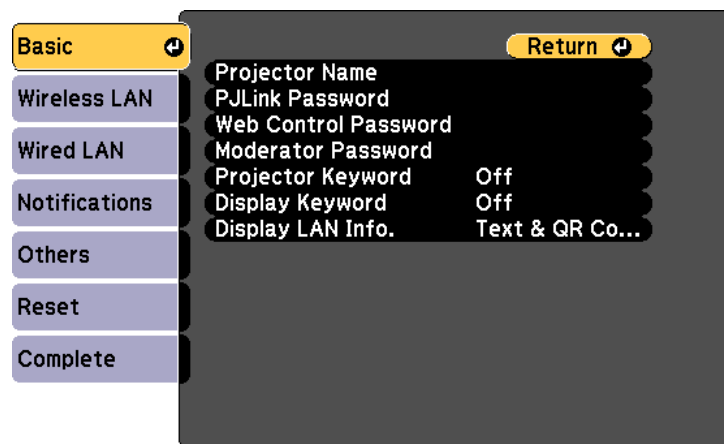

[Esc] / [Return]: Return [Left/Right Arrow]: Select

Submenu	Function
Moderator Password	Enter the four digit authentication password for using Epson iProjection when connecting to the projector as a moderator. (There is no default password.)
Projector Keyword	Set this to On to enable a security password to prevent other users from accidentally projecting images. When projecting images from a computer or mobile device, you need to enter the keyword displayed on the projection screen in Epson iProjection.
Display Keyword	When this is set to On and when connecting to the projector using Epson iProjection, the projector keyword is displayed on the projection screen. Only available when Projector Keyword is set to On .
Display LAN Info.	Set the display format for the projector's network information. If you display the QR code, you can connect to a network just by reading the QR code in Epson iProjection. Text & QR Code is set by default.

Submenu	Function
Projector Name	Enter the projector name used to identify the projector over a network. When editing, you can enter up to 16 single-byte alphanumeric characters. (" * + , / : ; < = > ? [\] ` and spaces cannot be used.)
PJLink Password	Set a password to use when you access the projector using compatible PJLink software. You can enter up to 32 single-byte alphanumeric characters. (Spaces and symbols cannot be used.) ☛ "About PJLink" p.143
Web Control Password	Set a password for authentication to use when making settings and controlling the projector using Epson iProjection or Epson Web Control. You can enter up to eight single-byte alphanumeric characters (* : and spaces cannot be used). The default user name is "EPSONWEB" and the default password is "admin". ☛ "Operating the Projector Using a Mobile Device or Computer" p.40

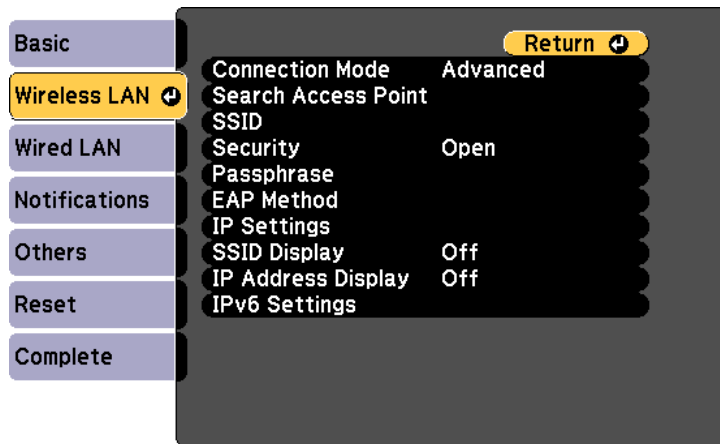

Wireless LAN menu



[Esc] / [↵]:Return [↵]:Select

Submenu	Function
Connection Mode	Set the connection mode to use when connecting the projector and a computer via a wireless LAN. Quick: Lets you directly connect to a smartphone, tablet, or computer via a wireless LAN. Advanced: Lets you connect to a smartphone, tablet, or computer over a wireless LAN access point. The connection is established in infrastructure mode.
Search Access Point	When Connection Mode is set to Advanced , you can search for surrounding access points, and set the SSID to be connected from those access points. Depending on the access point settings, they may not be displayed in the list.  "Search Access Point screen" p.107
SSID	Enter an SSID. When an SSID is provided for the wireless LAN system in which the projector participates, enter the SSID. You can enter up to 32 single-byte alphanumeric characters.

Submenu	Function
Security	Select the security type according to the wireless LAN settings. Off: Security is not set. WPA2-PSK: Communication is performed using WPA2 security. Uses AES method for encryption. When establishing a connection from a computer to the projector, enter the value set in the passphrase. WPA/WPA2-PSK*: Connects in WPA personal mode. Encryption method is selected automatically according to the access point settings. Set a passphrase which is the same for the access point. WPA2-EAP*: Communication is performed using WPA2 security. Uses AES method for encryption. WPA/WPA2-EAP*: Connects in WPA enterprise mode. Encryption method is selected automatically according to the access point settings.
Passphrase	Enter a passphrase used to connect to the network when Security is set to WPA2-PSK or WPA/WPA2-PSK . You can enter at least 8 and up to 63 single-byte alphanumeric characters. You can enter up to 32 characters on the Configuration menu. When entering more than 32 characters, use your Web browser to enter the text.  "Operating Using Epson Web Control (Web Browser)" p.40 When Connection Mode is set to Quick , the initial passphrase is set.

Submenu	Function
EAP Method	<p>Set protocols for WPA2-EAP and WPA/WPA2-EAP authentication.</p> <p>EAP Type: Select the certification protocol.</p> <ul style="list-style-type: none"> • PEAP: Authentication protocol widely used in Windows Server. • PEAP-TLS: Authentication protocol used in Windows Server. Select when using a client certificate. • EAP-TLS: Authentication protocol widely used to use a client certificate. • EAP-FAST, LEAP: Select this when these authentication protocols are used. <p>User Name: Enter a user name to be used for authentication. You can enter up to 64 single-byte alphanumeric characters.</p> <p>You can enter up to 32 characters on the Configuration menu. When entering more than 32 characters, use your Web browser to enter the text.</p> <p> "Operating Using Epson Web Control (Web Browser)" p.40</p> <p>If you also need to enter a domain name, add the domain name before the user name separated by a backslash (domain name\user name).</p> <p>Password: Enter the password used for authentication in PEAP, EAP-FAST, and LEAP. You can enter up to 64 single-byte alphanumeric characters. You can enter up to 32 characters on the Configuration menu. When entering more than 32 characters, use your Web browser to enter the text.</p> <p> "Operating Using Epson Web Control (Web Browser)" p.40</p> <p>When the password is entered and Finish is selected, the value is set and displayed as an asterisk (*).</p> <p>Client Certificate: Imports client certificates for use in PEAP-TLS and EAP-TLS.</p>

Submenu	Function
	<p>Verify Server Cert.: Set to On to perform verification for the certificate of the certification server. To verify a server certificate, you need to set CA certificate.</p> <p>CA certificate: Imports CA certificates for use in PEAP, PEAP-TLS, EAP-TLS, and EAP-FAST.</p> <p>RADIUS Serv.Name: Specify the name of the certification server. You can enter up to 32 single-byte alphanumeric characters.</p>
Channel	You can select the channels used to connect in Quick mode. If interference from other signals occurs, use a different channel.
IP Settings*	<p>Perform network settings.</p> <p>DHCP: Set to On to configure the network using DHCP. If this is set to On, you cannot set any more addresses.</p> <p>IP Address: You can enter the IP Address assigned to the projector. You can enter a number from 0 to 255 in each field of the address. However, the following IP addresses cannot be used. 0.0.0.0, 127.x.x.x, 224.0.0.0 to 255.255.255.255 (where x is a number from 0 to 255)</p> <p>Subnet Mask: You can enter the Subnet Mask for the projector. You can enter a number from 0 to 255 in each field of the address. However, the following subnet masks cannot be used. 0.0.0.0, 255.255.255.255</p> <p>Gateway Address: You can enter the IP address for the gateway for the projector. You can enter a number from 0 to 255 in each field of the address. However, the following Gateway Address cannot be used. 0.0.0.0, 127.x.x.x, 224.0.0.0 to 255.255.255.255 (where x is a number from 0 to 255)</p>
SSID Display	To prevent the SSID from being displayed on the LAN Standby screen, set this to Off .
IP Address Display	To prevent the IP address from being displayed on the LAN Standby screen, set this to Off .

Submenu	Function
IPv6 Settings	<p>Perform settings to use the IPv6 protocols.</p> <div style="border: 1px solid black; padding: 5px; margin: 10px 0;">  <ul style="list-style-type: none"> The following functions support IPv6 protocols. <ul style="list-style-type: none"> Epson Web Control PJLink When setting the IPv6 address manually, make settings in Advanced from Epson Web Control. <ul style="list-style-type: none"> "Operating the Projector Using a Mobile Device or Computer" p.40 </div> <p>IPv6: Set this to On when using IPv6 protocols. Make sure one link local address is set when using IPv6. This is composed of the interface ID created from fe80:: and the projector's MAC address.</p> <p>Auto Configuration: Set this to On to automatically acquire an IPv6 address from RA (Router Advertisement). The address is composed as shown below.</p> <ul style="list-style-type: none"> Stateless Address (0 to 6): Created automatically by combining the prefix acquired from the RA (Router Advertisement) and the interface ID created from the projector's MAC address. Stateful Address (0 to 1): Created automatically from the DHCP server using DHCPv6. <p>Use Temporary Address: Set this to On to temporarily validate the IPv6 address (0 to 1) when Auto Configuration is On.</p>

* This can be selected only when Connection Mode is set to **Advanced**.

Type of security

We recommend making security settings when using the projector in Advanced mode.

WPA is an encryption standard that improves the security for wireless networks. The projector supports TKIP and AES encryption methods.

WPA also includes user authentication functions. WPA authentication provides two methods: using an authentication server, or authenticating between a computer and an access point without using a server. This projector supports the latter method, without a server.





For setting details, follow the instructions from your network administrator.

Search Access Point screen

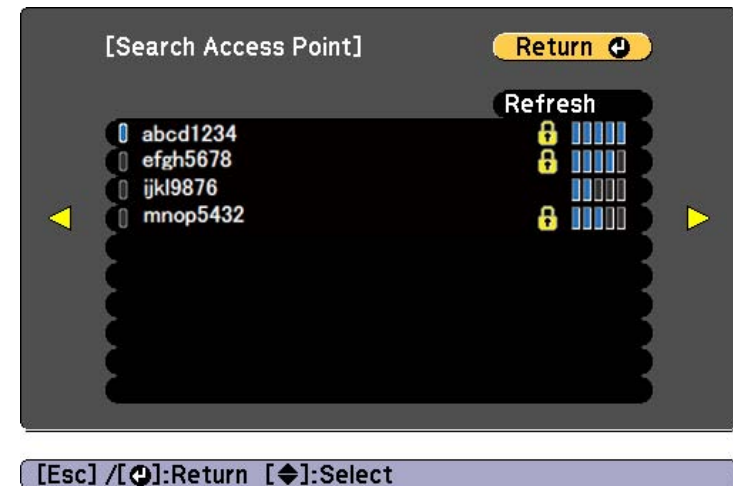
Detected access points are displayed in a list.



Submenu	Function
Refresh	Searches for the access point again.
	Indicates an already set access point.

Submenu	Function
	<p>Indicates the access points where security is set.</p> <p>If you select an access point where security has not been set, the Wireless LAN menu is displayed.</p> <p>If you select an access point where security has been set, the Security menu is displayed. Select a type of security according to the security settings for the access point.</p>

Wired LAN menu

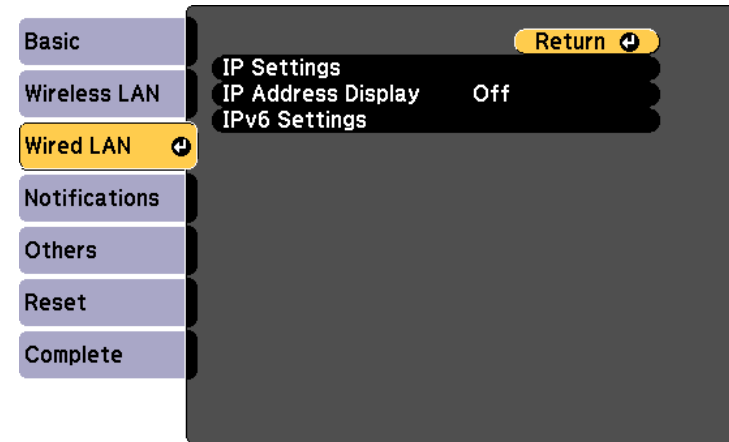

[Esc] / [⏪]:Return [↵]:Select

Submenu	Function
IP Settings	<p>You can make settings related to the following addresses.</p> <p>DHCP: Set to On to configure the network using DHCP. If this is set to On, you cannot set any more addresses.</p> <p>IP Address: You can enter the IP Address assigned to the projector. You can enter a number from 0 to 255 in each field of the address. However, the following IP addresses cannot be used. 0.0.0.0, 127.x.x.x, 224.0.0.0 to 255.255.255.255 (where x is a number from 0 to 255)</p> <p>Subnet Mask: You can enter the Subnet Mask for the projector. You can enter a number from 0 to 255 in each field of the address. However, the following subnet masks cannot be used. 0.0.0.0, 255.255.255.255</p> <p>Gateway Address: You can enter the IP address for the gateway for the projector. You can enter a number from 0 to 255 in each field of the address. However, the following Gateway Address cannot be used. 0.0.0.0, 127.x.x.x, 224.0.0.0 to 255.255.255.255 (where x is a number from 0 to 255)</p>

Submenu	Function
IP Address Display	To prevent the IP address from being displayed on the LAN Standby screen, set this to Off .
IPv6 Settings	<p>Perform settings to use the IPv6 protocols.</p> <div style="border: 1px solid black; padding: 5px; margin: 10px 0;">  <ul style="list-style-type: none"> The following functions support IPv6 protocols. <ul style="list-style-type: none"> Epson Web Control PJLink When setting the IPv6 address manually, make settings in Advanced from Epson Web Control. <ul style="list-style-type: none"> "Operating the Projector Using a Mobile Device or Computer" p.40 </div> <p>IPv6: Set this to On when using IPv6 protocols. Make sure one link local address is set when using IPv6. This is composed of the interface ID created from fe80:: and the projector's MAC address.</p> <p>Auto Configuration: Set this to On to automatically acquire an IPv6 address from RA (Router Advertisement). The address is composed as shown below.</p> <ul style="list-style-type: none"> Stateless Address (0 to 6): Created automatically by combining the prefix acquired from the RA (Router Advertisement) and the interface ID created from the projector's MAC address. Stateful Address (0 to 1): Created automatically from the DHCP server using DHCPv6. <p>Use Temporary Address: Set this to On to temporarily validate the IPv6 address (0 to 1) when Auto Configuration is On.</p>

Notifications Menu

When this is set, you receive an email notification if a problem or warning occurs in the projector.

☛ "Reading error notification mail" [p.142](#)

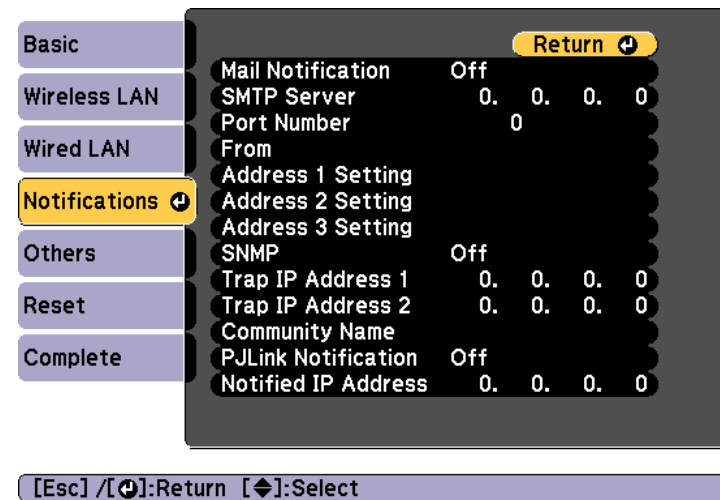



Submenu	Function
Mail Notification	Set to On to send an email to the preset addresses when a problem or warning occurs with a projector.
SMTP Server	<p>You can input the <u>IP Address</u> for the SMTP server for the projector.</p> <p>You can enter a number from 0 to 255 in each field of the address. However, the following IP addresses cannot be used. 127.x.x.x, 224.0.0.0 to 255.255.255.255 (where x is a number from 0 to 255)</p>
Port Number	You can input the port number for the SMTP server. The default value is 25. You can input numbers between 1 to 65535.
From	<p>Enter the email address of the sender. You can enter up to 64 single-byte alphanumeric characters. You can enter up to 32 characters on the Configuration menu. When entering more than 32 characters, use your Web browser to enter the text. ("() , ; < > [\] and spaces cannot be used.)</p> <p>☛ "Operating Using Epson Web Control (Web Browser)" p.40</p>

Submenu	Function
Address 1 Setting/Address 2 Setting/Address 3 Setting	Set the destination email addresses for the notification email, and the notification content. You can register up to three destinations. You can enter up to 64 single-byte alphanumeric characters. You can enter up to 32 characters on the Configuration menu. When entering more than 32 characters, use your Web browser to enter the text. ("() , ; < > [\] and spaces cannot be used.)  "Operating Using Epson Web Control (Web Browser)" p.40
SNMP	Set to On to monitor the projector using SNMP . To monitor the projector, you need to install the SNMP manager program on your computer. SNMP should be managed by a network administrator. The default value is Off .
Trap IP Address 1/Trap IP Address 2	You can register up to two IP addresses for the SNMP trap notification destination. You can enter a number from 0 to 255 in each field of the address. However, the following IP addresses cannot be used. 127.x.x.x, 224.0.0.0 to 255.255.255.255 (where x is a number from 0 to 255)
Community Name	Set the SNMP community name. You can enter up to 32 single-byte alphanumeric characters. (Spaces and symbols cannot be used.)
PJLink Notification	Set this to On to use the PJLink notification function.
Notified IP Address	Enter the IP address of the computer to which you want to send notifications of the projector's operating status using the PJLink notification function. You can enter a number from 0 to 255 in each field of the address. However, the following IP addresses cannot be used. 127.x.x.x, 224.0.0.0 to 255.255.255.255 (where x is a number from 0 to 255)

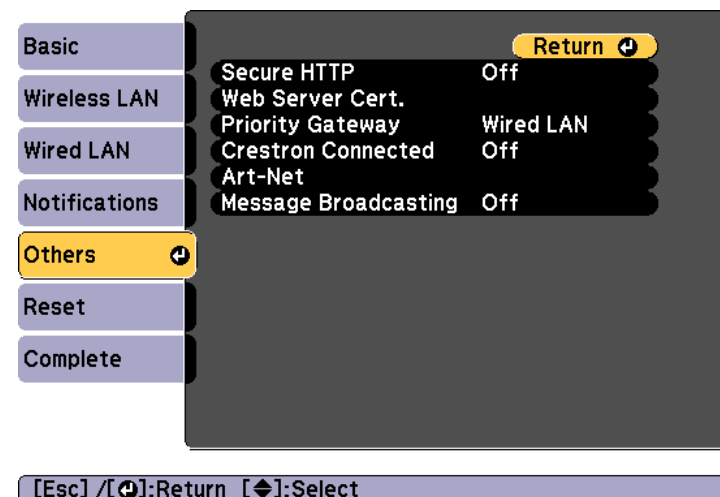
Others menu



Submenu	Function
Secure HTTP	To strengthen security, communication between the projector and computer in Epson Web Control is encrypted. When setting security with Epson Web Control, we recommend setting this to On .
Web Server Cert.	Imports the Web server certificate used in Secure HTTP.
Priority Gateway	For the priority gateway, select either Wired or Wireless .
Crestron Connected	Set this to On only when monitoring or controlling the projector over the network using Crestron Connected®. Otherwise, set this to Off .  "About Crestron Connected®" p.144 Changes in projector settings take effect upon restarting. When this is set to On , the following functions are not available. <ul style="list-style-type: none"> • The Message Broadcasting feature in the Epson Projector Management software

Submenu	Function
Art-Net	<p>Art-Net: Set this to On to control the projector using Art-Net.  "Art-Net" p.149</p> <p>Net/Sub-Net/Universe: Sets the projector's Net/Sub-Net/Universe.</p> <p>Start Channel: Sets the start channel that handles Art-Net.  "Channel definitions" p.149</p>
Message Broadcasting	<p>Set this to On to receive information sent by the Message Broadcasting feature in the Epson Projector Management software.</p> <p>Download software and User's Guides from the following Web site. http://www.epson.com</p>

Reset menu

Resets all of the network settings.

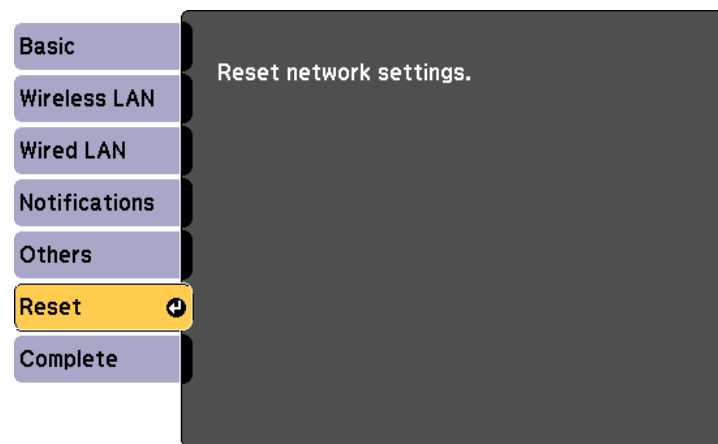

[↕]:Select [↵]:Enter

Submenu	Function
Reset network settings.	To reset all of the Network settings, select Yes .

Info Menu (Display Only)

Lets you check the status of the image signals being projected and the status of the projector. Items that can be displayed vary depending on the source currently being projected.

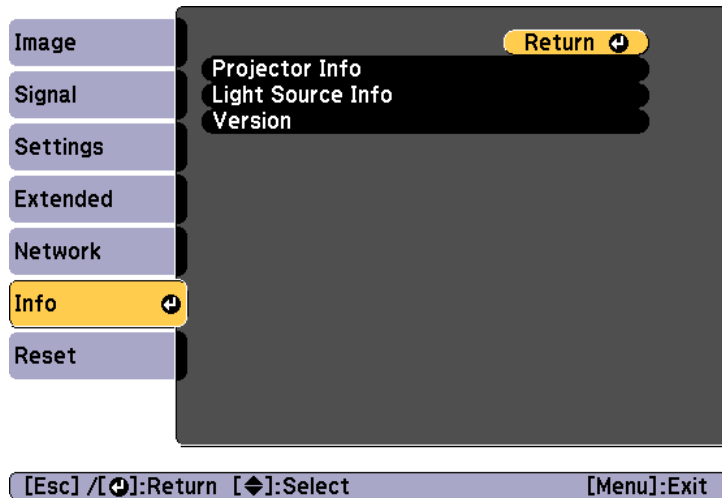

Submenu		Function
Projector Info	Operation Hours*	Displays the operation time after turning on the projector.
	Source	You can display the source name for the connected equipment currently being projected.
	Input Signal	You can display the content of Input Signal set in the Signal menu according to the source.
	Resolution	You can display the resolution.
	Refresh Rate	You can display the <u>Refresh Rate</u> ▶▶.

Submenu		Function
	Sync Info	You can display the image signal information. This information may be needed if service is required.
	Status	This is information about errors that have occurred on the projector. This information may be needed if service is required.
	Serial Number	Displays the projector's serial number.
	Event ID	When problems occur when the projector and computer are connected through the network, information on the problem is displayed using an Event ID. See the following page for information on interpreting the Event ID. 👉 "About Event ID" p.135
Light Source Info	Light Source Hours	Displays the operating time for the light source according to the Light Source Mode.
Version	Main	Displays the projector's firmware version information.

* The cumulative use time is displayed as "0H" for the first 10 hours. 10 hours and above is displayed as "10H", "11H", and so on.

Reset Menu

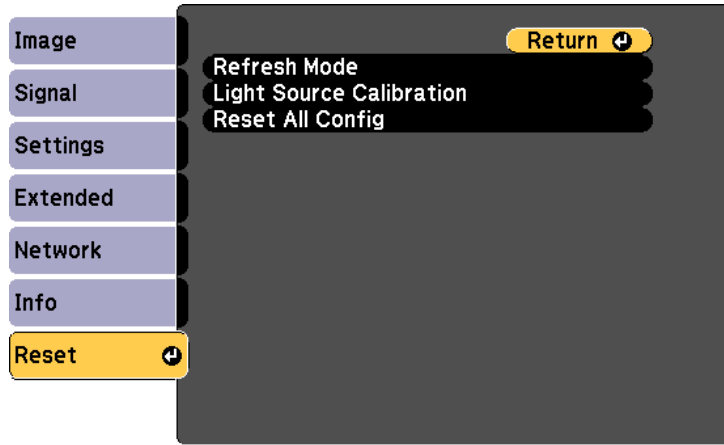

[Esc] / [Return]:Return [Down Arrow]:Select [Menu]:Exit

Submenu	Function
Reset All Config	You can reset all items in the Configuration menu to their default settings. The following items are not reset to their defaults: User's Logo , all items on the Network menu, , Language , Date & Time , Color Uniformity , Color Matching , Light Source Info , and Operation Hours .

Submenu	Function
Refresh Mode	☑ "Refresh Mode" p.139
Light Source Calibration	Make settings related to Light Source Calibration. <ul style="list-style-type: none"> • Run Now: Starts Light Source Calibration. You cannot use Run Now in the following situations. <ul style="list-style-type: none"> - Within 20 minutes of turning off the projector. - When the temperature of the local environment is high and the brightness of the light source is automatically reduced. • Run Periodically: When this is set to On, Light Source Calibration is performed every 100 hours of use. • Schedule Settings: Displays the schedule settings screen. Set Light Source Calibration to run periodically.

Once the Configuration menu content has been set for one projector, you can use it to perform batch setup for multiple projectors (batch setup function). The batch setup function is only for projectors with the same model number.

Use one of the following methods.

- Make settings using an SD card.
- Setup using EasyMP Network Updater.

This guide explains how to use the SD card.



- The following content is not reflected by the batch setup function.
 - The Network menu settings (except for the Notifications menu and the Others menu)
 - Status and Light Source Info in the Info menu
- Perform batch setup before adjusting the projected image. Adjustment values for the projected image, such as Keystone are reflected by the batch setup function. If batch setup is performed after adjusting the projected image, the adjustments you made may change.
- By using the batch setup function, the registered User's Logo is set for the other projectors. Do not register confidential information and so on as the User's Logo.



Caution

Performing batch setup is the customers responsibility. If batch setup fails due to a power failure, communication error, and so on, the customer is responsible for any repair costs incurred.

Making Settings Using an SD Card

This section explains how to perform batch setup using an SD card.

Saving settings to an SD card

- 1** Disconnect the power cord from the projector, and check that all of the projector's indicators have turned off.
- 2** Insert an SD card into the projector.

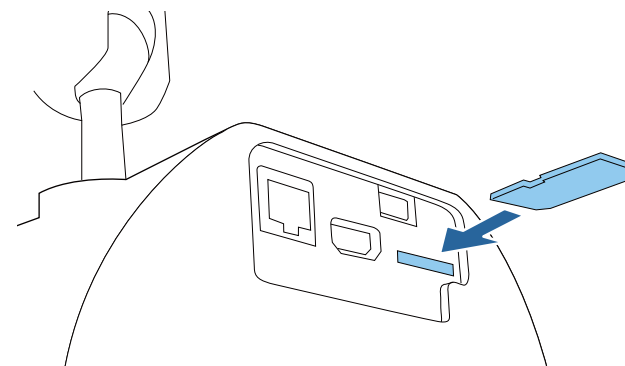

- Connect an empty SD card. If the SD card contains data other than the batch setup file, the settings may not be saved correctly.
- If you have saved a batch setup file from another projector to the SD card, delete the file or change the file name. The batch setup function cannot overwrite a batch setup file.
- The file name for the batch setup file is PJCONFDATA.bin. If you need to change the file name, add text after PJCONFDATA. If you change the file name in any other way, the projector may not be able to recognize the file correctly.
- You can only use single-byte characters for the file name.

- 3** While holding down the [Esc] on the remote control or the control panel, connect the power cord to the projector.

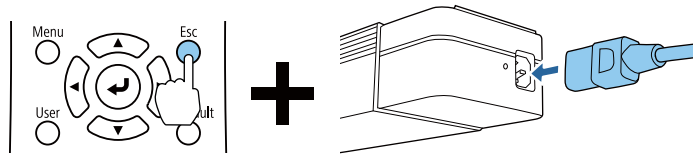

When the projector's indicators turn on as follows, release the [Esc] button.

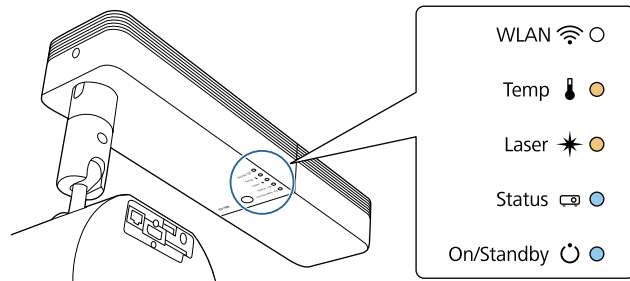

On/Standby	Status	Laser	Temp
Blue - On	Blue - On	Orange - On	Orange - On

When all of the indicators start flashing, the settings are being written to the batch setup file.

⚠ Caution

- Do not disconnect the power cord from the projector while the file is being written. If the power cord is disconnected, the projector may not start correctly.
- Do not disconnect the SD card from the projector while the file is being written. If the SD card is disconnected, the projector may not start correctly.

When writing completes normally, the projector enters standby status.

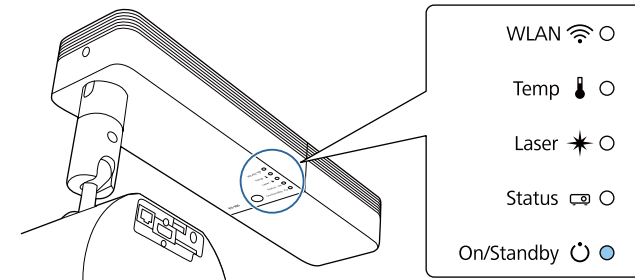

On/Standby
Blue - On

When the projector is in standby status, remove the SD card.

Reflecting saved settings to other projectors

- 1** Disconnect the power cord from the projector, and check that all of the projector's indicators have turned off.
- 2** Insert the SD card on which the settings have been saved into the projector.

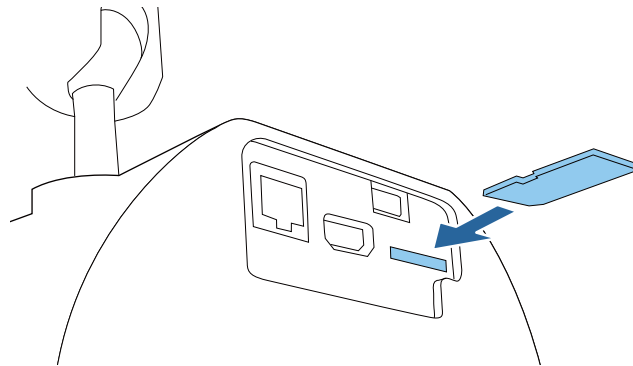

- When the SD card contains 1 to 3 types of batch setup files, the file is reflected to the projector with the same model number. If there are multiple files for a projector with the same model number, the settings may not be reflected correctly.
- When there are four or more types of batch setup files on the SD card, the settings may not be reflected correctly.
- Do not store any data except for the batch setup file on the SD card. If the SD card contains data other than the batch setup file, the settings may not be reflected correctly.

- 3** While holding down the [Menu] on the remote control or the control panel, connect the power cord to the projector.

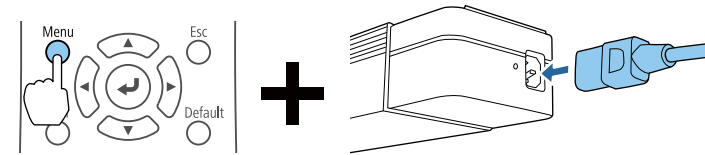

When the projector's indicators turn on as follows, release the [Menu] button.

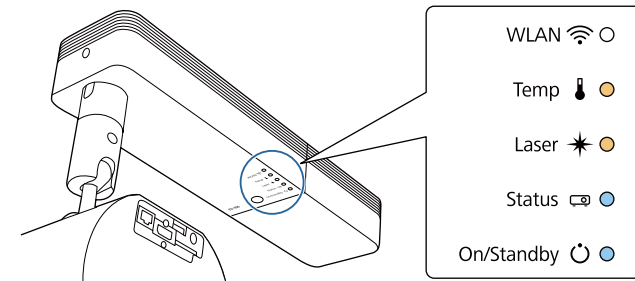

On/Standby	Status	Laser	Temp
Blue - On	Blue - On	Orange - On	Orange - On

The indicators remain on for about 75 seconds.

When all of the indicators start flashing, the settings are being written.

Caution

- Do not disconnect the power cord from the projector while the settings are being written. If the power cord is disconnected, the projector may not start correctly.
- Do not disconnect the SD card from the projector while the settings are being written. If the SD card is disconnected, the projector may not start correctly.



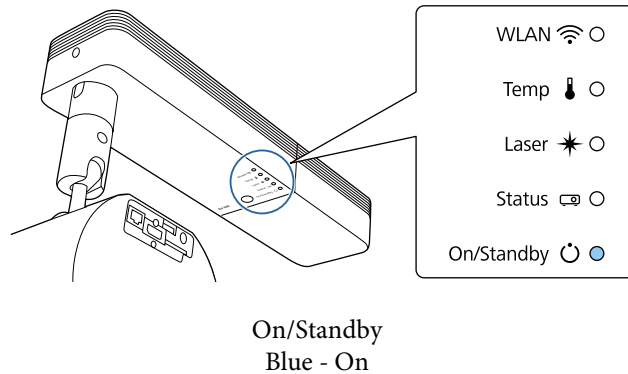

















- 4** When writing completes normally, the projector enters standby status.



When the projector is in standby status, remove the SD card.

When Setup Fails

The indicators notify you if an error occurs. Check the status of the projector's indicators and follow the instructions described in the table here.

Indicator status	Remedy
WLAN   Temp   Laser   Status   On/Standby   Temp: Orange - flashing fast Laser: Orange - flashing fast	The batch setup file may be corrupt, or the SD card may not be connected correctly. Disconnect the SD card, unplug and then plug in the projector's power cord, and then try again.
WLAN   Temp   Laser   Status   On/Standby   Temp: Orange - flashing fast Laser: Orange - flashing fast Status: Blue - flashing fast On/Standby: Blue - flashing fast	Writing the settings may have failed and an error may have occurred in the projector's firmware. Stop using the projector, remove the power plug from the electrical outlet, and contact your local dealer or the nearest address provided in the Epson Projector Contact List.  Epson Projector Contact List



Troubleshooting

This chapter explains how to identify problems and what to do if a problem is found.

This projector has the following five indicators to indicate the projector's status.

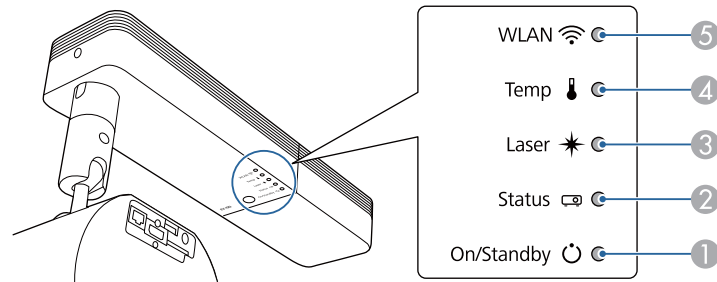

















- ① On/Standby indicators
Indicates the projector's status.
- ② Status indicator
Indicates the projector's status.
- ③ Laser indicator
Indicates the light source status.
- ④ Temp indicator
Indicates the internal temperature status. This is normally turned off.
- ⑤ WLAN indicator
Indicates the wireless LAN status.

The following indicator status are used during regular operation.















"Status varies" indicates that the indicators turn on, off, or flash depending on the status of the projector.









Indicator				Projector's Status	Explanation
On/Standby	Status	Laser	Temp		
● Blue - On	○ Off	○ Off	○ Off	Standby condition	Power is being supplied to the projector. In this status, you can start projecting by pressing the [⏻] button on the remote control or on the projector. (Sometimes, when the power cord is unplugged, the On/Standby indicator remains lit for a short period, but this is not a fault.)
				Network monitoring status	The projector is being monitored and controlled over a network (when Standby Mode is set to Communication On). If the power cord is disconnected and then reconnected in this status, the On/Standby indicator flashes blue.
● Blue - On	⚡ Blue - Flashing	○ Off	○ Off	Warm-up status	This is the status immediately after turning on the projector. Warm-up takes approximately 30 seconds after the light source turns on. The [⏻] button is disabled during warm-up.
● Blue - On	● Blue - On	● Status varies	○ Off	Projecting	The projector is projecting.

Indicator				Projector's Status	Explanation
On/Standby	Status	Laser	Temp		
 Blue - On	 Blue - Flashing	 Off	 Off	Cool down status	This is the status immediately after turning off the power. In this status, all buttons are disabled.
 Blue - Flashing	 Off	 Off	 Off	Preparing Network monitoring	Preparing to monitor and control this projector over a network. During network monitoring preparation, all button operations are disabled.
 Blue - On	 Blue - On	 Off	 Off	A/V Mute activated	A/V Mute is active.
 Status varies	 Blue - Flashing	 Orange - Flashing	 Status varies	Refresh Mode activated	Refresh Mode is active.



When an error has occurred in the projector, the error status is indicated by the indicator's color and combination of flashing or lit.

Refer to the following table to see what the indicators mean and how to remedy problems that they indicate.

Indicator				Cause	Remedy or Status
On/Standby	Status	Laser	Temp		
○ Off	 Blue - Flashing	 Orange - Flashing	○ Off	Internal Error	Stop using the projector, remove the power plug from the electrical outlet, and contact your local dealer or the nearest address provided in the Epson Projector Contact List.  Epson Projector Contact List
○ Off	 Blue - Flashing	○ Off	 Orange - Flashing	Fan Error Sensor Error	Stop using the projector, remove the power plug from the electrical outlet, and contact your local dealer or the nearest address provided in the Epson Projector Contact List.  Epson Projector Contact List
○ Off	 Blue - Flashing	○ Off	 Orange - On	High Temp Error (Overheating)	<p>The light source turns off automatically and projection stops. Wait for about five minutes. The projector enters standby status after approximately five minutes.</p> <p>Check the following three points.</p> <ul style="list-style-type: none"> • Check that the Air intake vent, Air exhaust vent and the slit in the side of the projector are clear, and that the projector is not positioned against a wall. • If dust adheres to the Air intake vent, Air exhaust vent, or the slit in the side of the projector, turn off the projector, unplug the power plug from the outlet, and then clean. <ul style="list-style-type: none">  "Cleaning the Projector's Surface" p.138  "Cleaning the Air Intake Vent and the Air Exhaust Vent" p.138 • Check if the air intake temperature is too high. <p>If the error continues, stop using the projector, remove the power plug from the electrical outlet, and contact your local dealer or the nearest address provided in the Epson Projector Contact List.  Epson Projector Contact List</p>
					When using at an altitude of 1500 m or more, set High Altitude Mode to On .  Extended - Operation - High Altitude Mode p.99
○ Off	 Blue - Flashing	 Orange - On	○ Off	Laser Error Retardation Plate Error	Stop using the projector, remove the power plug from the electrical outlet, and contact your local dealer or the nearest address provided in the Epson Projector Contact List.  Epson Projector Contact List

Indicator				Cause	Remedy or Status
On/Standby	Status	Laser	Temp		
 Blue - Flashing	 Status varies	 Status varies	 Orange - Flashing	High Temp Warning	This is not an error. However, if the temperature rises too high again, projection stops automatically. Check the following two points. <ul style="list-style-type: none"> • Check that the Air intake vent, Air exhaust vent and the slit in the side of the projector are clear, and that the projector is not positioned against a wall. • If dust adheres to the Air intake vent, Air exhaust vent, or the slit in the side of the projector, turn off the projector, unplug the power plug from the outlet, and then clean. <ul style="list-style-type: none"> ☛ "Cleaning the Projector's Surface" p.138 ☛ "Cleaning the Air Intake Vent and the Air Exhaust Vent" p.138 • Check if the air intake temperature is too high.
 Blue - Flashing	 Status varies	 Orange - Flashing	 Status varies	Laser Warning	Stop using the projector, remove the power plug from the electrical outlet, and contact your local dealer or the nearest address provided in the Epson Projector Contact List. <ul style="list-style-type: none"> ☛ Epson Projector Contact List

Wireless LAN status

WLAN indicator status	Problem and solutions
 Blue - On	Wireless LAN is available.
 Flashing blue quickly	Connecting to device.
 Flashing blue slowly	An error has occurred. Turn the projector off and then on again.











WLAN indicator status	Problem and solutions
○ Off	Wireless LAN is un-available. Make sure the wireless LAN settings are correct.



- See the following if the projector is not operating properly, even though the indicators are all showing normal.
 - ☛ "Problem Solving" [p.124](#)
- If the indicators are in a state not shown in this table, stop using the projector, remove the power plug from the electrical outlet, and contact your local dealer or the nearest address provided in the Epson Projector Contact List.
 - ☛ [Epson Projector Contact List](#)

If any of the following problems occur and the indicators do not offer a solution, refer to the pages given for each problem.

Problems Relating to Images





<ul style="list-style-type: none"> • No images appear Projection does not start, the projection area is completely black, or the projection area is completely blue. 	 p.125
<ul style="list-style-type: none"> • Moving images are not displayed Videos played back are black or no image is projected, or the video is not played back on the computer. 	 p.125
<ul style="list-style-type: none"> • The playlist does not play. 	 p.126
<ul style="list-style-type: none"> • The message "Not supported" is displayed 	 p.126
<ul style="list-style-type: none"> • The message "No Signal" is displayed 	 p.126
<ul style="list-style-type: none"> • Images are fuzzy, out of focus, or distorted 	 p.127
<ul style="list-style-type: none"> • Interference or distortion appear in images 	 p.127
<ul style="list-style-type: none"> • The image is truncated (large) or small, the aspect ratio is not suitable, or the image has been reversed Only part of the image is displayed, the height and width ratios of the image are not correct, or the image may appear reversed from top to bottom or left to right. 	 p.127
<ul style="list-style-type: none"> • Image colors are not right The whole image appears purplish or greenish, images are black & white, or colors appear dull. 	 p.128
<ul style="list-style-type: none"> • Images appear dark 	 p.129
<ul style="list-style-type: none"> • Burning appears on the LCD panel. 	 p.129

Problems when Projection Starts







<ul style="list-style-type: none"> • The projector does not turn on 	 p.129
---	---

Solving Network Problems

<ul style="list-style-type: none"> • Solutions When Wireless Authentication Fails 	 p.130
---	---

<ul style="list-style-type: none"> • Solutions When You Cannot Access the Projector using a Web browser 	 p.130
<ul style="list-style-type: none"> • Cannot operate the SD card using a Web browser (save/delete playlist, upload data). 	 p.131
<ul style="list-style-type: none"> • Email is not received even if a problem occurs in the projector 	 p.131
<ul style="list-style-type: none"> • Solutions When the Image Contains Static During Network Projection 	 p.131

Other Problems

<ul style="list-style-type: none"> • No sound can be heard or the sound is faint 	 p.132
<ul style="list-style-type: none"> • The remote control does not work 	 p.132
<ul style="list-style-type: none"> • I want to change the language for messages and menus 	 p.133
<ul style="list-style-type: none"> • Solutions to Password Problems 	 p.133
<ul style="list-style-type: none"> • "The battery that saves your clock settings is running low." is displayed 	 p.133
<ul style="list-style-type: none"> • Detailed logs and error message are not displayed 	 p.133
<ul style="list-style-type: none"> • Cannot control Art-Net correctly. 	 p.134

Problems Relating to Images

No images appear

Check	Remedy
Did you press the [⏻] button on the remote control or the projector?	Press the [⏻] button to turn on the power.
Are the indicators switched off?	The power cord is not connected correctly or power is not being supplied. Connect the projector's power cord correctly. Check that your electrical outlet or power source is functioning correctly.
Is A/V Mute active?	Press the [A/V Mute] button to release A/V Mute. ☛ "Hiding the Image and Sound Temporarily (A/V Mute)" p.58
Are the Configuration menu settings correct?	Reset all of the settings. ☛ Reset - Reset All Config p.113
Is the image to be projected completely black? (Only when projecting computer images)	Some input images, such as screen savers, may be completely black.
Is Windows Media Center displayed in full screen? (Only during network connection)	When Windows Media Center is displayed at full screen, you cannot project using a network connection. Reduce the screen size.
Is an application using the Windows DirectX function displayed? (Only during network connection)	Applications using the Windows DirectX function may not display images correctly.

Moving images are not displayed

Check	Remedy
Is the computer's image signal being output to the LCD and the monitor? (Only when projecting images from a laptop computer or a computer with a built-in LCD screen)	Change the image signal from the computer to external output only. Check your computer's documentation, or contact the computer's manufacturer.
Are the contents of the moving image you are trying to project copyright protected?	The projector may not be able to project copyright protected moving images that are being played back on a computer. For more details, see the user's guide supplied with the player.

The playlist does not play.

Check	Remedy
Have you saved a playlist to the SD card?	The playlist may not have been saved correctly to the SD card. Check the data on the SD card.

"Not supported" is displayed

Check	Remedy
Do the image signal resolution and the refresh rate correspond to the mode? (Only when projecting computer images)	Refer to the computer's documentation for how to change the image signal resolution and the refresh rate output from the computer. ☛ "Supported Monitor Displays" p.157

"No Signal" is displayed

Check	Remedy
Are the cables connected correctly?	Make sure that the necessary cables for projection are securely connected, or that the SD card is inserted correctly. Check that no cables are disconnected and that there are no poor contacts in the cables.
Is the correct port selected?	Press the [HDMI], [LAN], or [SD ►] button on the remote control to switch the image depending on the input source you want to project. ☛ "Switching to the Target Image by Remote Control" p.36
Is the power for the computer or video source turned on?	Turn the power on for the equipment.
Are the image signals being output to the projector? (Only when projecting images from a laptop computer or a computer with a built-in LCD screen)	If the image signals are only being output to the computer's LCD monitor or to the accessory monitor, you need to change the output to an external destination as well as the computer's own monitor. For some computer models, when the image signals are output externally, they no longer appear on the LCD monitor or accessory monitor. If the connection is made while the power of the projector or computer is already turned on, the Fn key (Function key) that changes the computer's image signal to external output may not work. Turn the power for the computer and the projector off and then back on again. ☛ Computer's documentation

Images are fuzzy, out of focus, or distorted

Check	Remedy
Is the focus adjusted correctly?	Make sure that at least 20 minutes has passed after the projection starts, and press the [Focus] button on the remote control to adjust the focus. ☛ "Correcting the Focus" p.49
Is the projector at the correct distance?	Is it projecting outside of the recommended projection distance range? Setup within the recommended range. ☛ "Screen Size and Projection Distance" p.155
Has condensation formed on the lens?	If the projector is suddenly taken from a cold environment to a warm environment, or if sudden ambient temperature changes occur, condensation may form on the surface of the lens, and this may cause the images to appear fuzzy. Set the projector up in the room about one hour before it is used. If condensation forms on the lens, turn the projector off and wait for the condensation to disappear.

Interference or distortion appear in images

Check	Remedy
Are the cables connected correctly?	Make sure that the necessary cables for projection are securely connected, or that the SD card is inserted correctly. Check that no cables are disconnected and that there are no poor contacts in the cables. ☛ "Connecting to Various Devices" p.24
Is an extension cable being used?	If an extension cable is used, electrical interference may affect the signals.
Is the correct resolution selected? (Only when projecting computer images)	Set the computer so that the signals being output are compatible with the projector. ☛ "Supported Monitor Displays" p.157 ☛ Computer's documentation

The image is truncated (large) or small, the aspect is not suitable, or the image has been reversed

Check	Remedy
Is the aspect adjusted correctly?	Select Aspect from the Configuration menu to select an aspect suitable for the input source. ☛ "Changing the Aspect Ratio of the Projected Image" p.54

Check	Remedy
Is Scale turned on?	Set Scale to Off on the Configuration menu. ☛ Signal - Scale p.97
Is the computer set for dual display? (Only when projecting computer images)	If dual display is activated in the Display Properties of the computer's Control Panel, only about half of the image on the computer screen is projected. To display the entire image on the computer screen, turn off the dual display setting. ☛ Computer video driver documentation
Is the correct resolution selected? (Only when projecting computer images)	Set the computer so that the signals being output are compatible with the projector. ☛ "Supported Monitor Displays" p.157 ☛ Computer's documentation
Is the image direction correct?	Make the correct settings in Projection from the Configuration menu. ☛ "Setting the Image Orientation (Projection)" p.28

Image colors are not right

Check	Remedy
Is the image brightness adjusted correctly?	Adjust the Brightness setting from the Configuration menu. ☛ Image - Brightness p.96
Are the cables connected correctly?	Make sure that the necessary cables for projection are securely connected, or that the SD card is inserted correctly. Check that no cables are disconnected and that there are no poor contacts in the cables. ☛ "Connecting to Various Devices" p.24
Is the Contrast adjusted correctly?	Adjust the Contrast setting from the Configuration menu. ☛ Image - Contrast p.96
Is the color adjustment set correctly?	Adjust the Gamma setting from the Configuration menu. ☛ Image - Advanced p.96
Are the color saturation and tint adjusted correctly?	Adjust the Color Saturation and Tint settings from the Configuration menu. ☛ Image - Color Saturation, Tint p.96

Check	Remedy
Is Light Source Calibration set correctly?	<p>If you are projecting using multiple projectors, and only some projectors change color, you may need to perform Light Source Calibration.</p> <p>Perform Light Source Calibration on all of the projectors.</p> <ul style="list-style-type: none"> ☛ Reset - Light Source Calibration p.113 <p>If you do not want to start Light Source Calibration automatically, set Run Periodically to Off.</p> <ul style="list-style-type: none"> ☛ Reset - Light Source Calibration - Run Periodically p.113

Images appear dark

Check	Remedy
Is the image brightness set correctly?	<p>Check the Brightness and Brightness Settings values from the Configuration menu.</p> <ul style="list-style-type: none"> ☛ Image - Brightness p.96 ☛ Settings - Brightness Settings p.98
Is the <u>Contrast</u> adjusted correctly?	<p>Adjust the Contrast setting from the Configuration menu.</p> <ul style="list-style-type: none"> ☛ Image - Contrast p.96



Burning appears on the LCD panel.

Check	Remedy
Reduces burning.	<p>Select Refresh Mode - Start from the Configuration menu.</p> <ul style="list-style-type: none"> ☛ "Refresh Mode" p.139

Problems when Projection Starts



The projector does not turn on

Check	Remedy
Did you press the [⏻] button on the remote control or the projector?	Press the [⏻] button to turn on the power.

Check	Remedy
Are the indicators switched off?	The power cord is not connected correctly or power is not being supplied. Disconnect and then reconnect the power cord. Check that your electrical outlet or power source is functioning correctly.
Do the indicators turn on and off when the power cord is touched?	There is probably a poor contact in the power cord, or the power cord may be defective. Reinsert the power cord. If this does not solve the problem, stop using the projector, disconnect the power cord from the electrical outlet, and contact your local dealer or the nearest address provided in the Epson Projector Contact List.  Epson Projector Contact List
Is the correct setting for the Remote Receiver selected?	Check the Remote Receiver from the Configuration menu.  Settings - Remote Receiver p.98
Was the power cord plugged back in or was the breaker turned on immediately after direct shutdown?	If the operation described in the column on the left is performed when Direct Power On is set to On , the power may not turn back on. Press the [⏻] button to turn on the power.

Solving Network Problems

Solutions When Wireless Authentication Fails

Check	Remedy
Check the date and time settings.	If the wireless settings are correct, but authentication fails, you may need to update the Date & Time settings on the projector's Extended menu.  "Setting the Date and Time" p.30
Check the security settings.	Check the Security settings in the projector's Network menu.  "Setting Up Wireless Network Security" p.84

Solutions When You Cannot Access the Projector using a Web browser

Check	Remedy
Are you using the correct user name and password?	To open the home screen from a Web browser, enter "EPSONWEB" as the user name. (You cannot change the user ID.) Enter the password set in the projector's Network menu for options other than Remote . The default password is "admin".  Network - Basic - Web Control Password p.104

Check	Remedy
Can you access the network to which the projector is connected?	If your Web browser is set up to connect through a proxy server, the Home screen cannot be displayed. Make settings for a connection without using a proxy server.

Cannot operate the SD card using a Web browser (save/delete playlist, upload data).

Check	Remedy
Is the SD card write protected?	Release the write protection from the SD card.

Email is not received even if a problem occurs in the projector

Check	Remedy
Are you connected to the network?	(If an error shuts down the projector, the email may not be delivered.)
Is Standby Mode set to Communication On ?	To use the Mail Notification function when the projector is in standby, set Communication On in Standby Mode from the Configuration menu. Also, change the Port according to the network environment in which it is being used. ☛ Extended - Standby Mode p.99
Is power being supplied to the projector?	Check that your electrical outlet or power source is functioning correctly.
Is the Mail Notification function set correctly in the Configuration menu?	An error notification email is sent according to the Notifications settings in the Configuration menu. Check if it is set correctly. ☛ "Notifications Menu" p.109

Solutions When the Image Contains Static During Network Projection

Check	Remedy
Check the signal status.	Check for any obstacles between the access point, the computer, the mobile device, and the projector, and change their positions to improve communication. Make sure that the access point, the computer, the mobile device and the projector are not too far apart. If the wireless connection is slow or your projected image contains noise, check for interference from other equipment, such as a Bluetooth device or microwave. Move the interfering device farther away or expand your wireless bandwidth.

Other Problems

No sound can be heard or the sound is faint

Check	Remedy
Check that the audio/video cable is securely attached to both the projector and audio source.	Disconnect the cable from the Audio Out port, and then reconnect the cable.
Is the projector volume set to the minimum?	Adjust the volume so that sound can be heard. ⚙️ Settings - Volume p.98 ⚙️ "Adjusting the Volume" p.57
Is the volume for the computer or from the image source set to the minimum?	Adjust the volume so that sound can be heard.
Is A/V Mute active?	Press the [A/V Mute] button to release A/V Mute. ⚙️ "Hiding the Image and Sound Temporarily (A/V Mute)" p.58

The remote control does not work

Check	Remedy
Is the remote control light-emitting area pointing towards the remote receiver on the projector during operation?	Point the remote control towards the remote receiver. ⚙️ "Remote control operating range" p.27
Is the remote control too far from the projector?	Check the operating range. ⚙️ "Remote control operating range" p.27
Is direct sunlight or strong light from fluorescent lamps shining onto the remote receiver?	Set the projector up in a location where strong light does not shine onto the remote receiver.
Is the correct setting for the Remote Receiver selected?	Check the Remote Receiver from the Configuration menu. ⚙️ Settings - Remote Receiver p.98
Are the batteries dead or have the batteries been inserted correctly?	Make sure the batteries are inserted correctly or replace the batteries with new ones if necessary. ⚙️ "Inserting Batteries into the Remote Control" p.26

I want to change the language for messages and menus

Check	Remedy
Change the Language setting.	Adjust the Language setting from the Configuration menu.  Extended - Language p.99

Solutions to Password Problems

Check	Remedy
Has a password been set?	You may have turned on Password Protection without first setting a password. Try entering "0000" using the remote control.
Has the correct password been entered?	If you enter an incorrect password too many times, a "Request Code" message is displayed. Make a note of this code, and then contact your local dealer or the nearest address provided in the Epson Projector Contact List. Provide the request code and proof of ownership for assistance in unlocking the projector.
Do you have the remote control?	If you lose the remote control you cannot enter a password. Order a new one from Epson.

"The battery that saves your clock settings is running low. " is displayed

Check	Remedy
The internal power supply that saves your clock settings is running low.	Contact your local dealer or the nearest address provided in the Epson Projector Contact List.  Epson Projector Contact List

Detailed logs and error message are not displayed

Check	Remedy
Depending on the environment, errors and warnings may not be displayed when turning on the projector after a sudden voltage drop, blackout, or power cut.	Wait for at least 10 seconds after turning off the projector using the power button or pulling the plug out of the outlet before turning the projector back on or re-inserting the plug in the outlet. When the projector turns on, check the status information.







Cannot control Art-Net correctly.

Check	Remedy
Have you operated the projector using the remote control while controlling in Art-Net?	If you operate the projector using the remote control while controlling the projector using Art-Net, settings made by the DMX controller or application software may not be applied to the projector. When you want to apply all the channel controls to the projector, set Channel 13 to "Cannot control", then set it back to "Can control".  "Art-Net" p.149

Check the numbers and then apply the following countermeasures. If you cannot resolve the problem, contact your network administrator, or contact your local dealer or the nearest address provided in the Epson Projector Contact List.

 [Epson Projector Contact List](#)

Event ID	Cause	Remedy
0432 0435	Failed to start the network software.	Restart the projector.
0434 0481 0482 0485	Network communication is unstable.	Check the network communication status, and reconnect after waiting for a while.
0433	Cannot play transferred images.	Restart the network software.
0484	Communication was disconnected from the computer.	
0483 04FE	The network software ended unexpectedly.	Check the status of network communications. Restart the projector.
0479 04FF	A system error occurred in the projector.	Restart the projector.
0891	Cannot find an access point with the same SSID.	Set the computer, the access point, and the projector to the same SSID.
0892	The WPA/WPA2 authentication type does not match.	Check that the wireless LAN security settings are correct.
0893	The WEP/TKIP/AES encryption type does not match.	 Network - Wireless LAN p.105
0894	Communication was disconnected because the projector connected to an unauthorized access point.	Contact your network administrator for more information.
0898	Failed to acquire DHCP.	Check that the DHCP server is operating correctly. If you are not using DHCP, set it to Off .  Network - Wireless LAN p.105 , Wired LAN p.108
0899	Other communication errors	If restarting the projector or network software does not solve the problem, contact your local dealer or the nearest address provided in the Epson Projector Contact List.  Epson Projector Contact List
089A	The EAP authentication type is not the same.	Check that the wireless LAN security settings are correct. Also, check if the certificate is installed correctly.  Network - Wireless LAN p.105
089B	EAP server authentication failed.	
089C	EAP client authentication failed.	
089D	Key exchange failed.	



Event ID	Cause	Remedy
0920	The internal power supply that saves your clock settings is running low.	Contact your local dealer or the nearest address provided in the Epson Projector Contact List. Epson Projector Contact List



Maintenance

This chapter provides information on maintenance procedures to ensure the best level of performance from the projector for a long time to come.

You should clean the projector if it becomes dirty or if the quality of projected images starts to deteriorate.

Caution

When cleaning, disconnect the power plug from the outlet, or turn off the circuit breaker. Otherwise, it could cause an electric shock.

Cleaning the Projector's Surface

Clean the projector's surface by wiping it gently with a soft cloth.

If the projector is particularly dirty, moisten the cloth with water containing a small amount of neutral detergent, and then firmly wring the cloth dry before using it to wipe the projector's surface.

Attention

Do not use volatile substances such as wax, alcohol, or thinner to clean the projector's surface. The quality of the case may change or become discolored.

Use a vacuum cleaner to clean dust from the slit in the side of the projector.

Cleaning the Lens

Use a commercially available cloth for cleaning glasses to gently wipe the lens.

Warning

Do not use sprays that contain flammable gas to remove dust and lint from the lens. The projector may catch fire due to the high internal temperature.

Attention

Do not rub the lens with harsh materials or subject the lens to shocks, as it can easily become damaged.

Cleaning the Air Intake Vent and the Air Exhaust Vent

Use a vacuum cleaner to remove dust from the front of the Air intake vent and the Air exhaust vent.

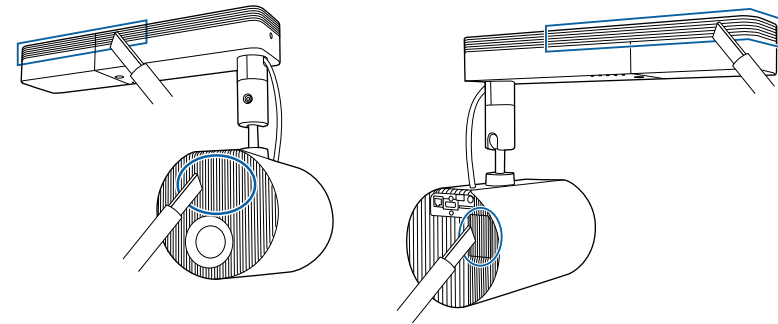

Color Uniformity

If you are concerned about uneven colors in the projected image, make adjustments using Color Uniformity.

☛ "Adjusting uneven colors (Color Uniformity)" [p.65](#)

Refresh Mode

When still images or images that move a little are projected for an extended period, an afterimage (image burning) may remain in the projected image.

You can reduce burning using Refresh Mode.

☛ **Reset - Refresh Mode** [p.113](#)

The power turns off after a set time has passed.



- To use the effect functions, make sure you perform Refresh Mode regularly.
- If an after image (image burning) remains after performing Refresh Mode, contact your local dealer or the nearest address provided in the Epson Projector Contact List.
☛ [Epson Projector Contact List](#)
- Under the following conditions, Refresh Mode stops automatically and the projector turns off.
 - When receiving Message Broadcasting
 - When receiving an error notification
 - When a phase difference plate warning (error) occurs

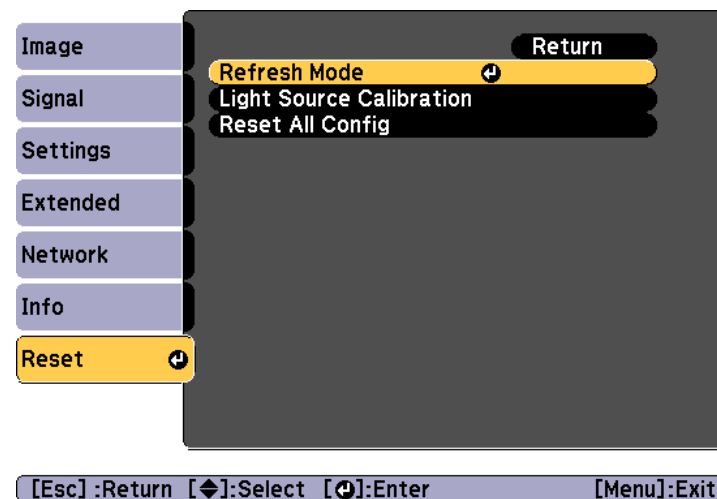

- 1 Press the [Menu] button while projecting.
- 2 Select **Refresh Mode** from **Reset**, and then press the [**↵**] button.

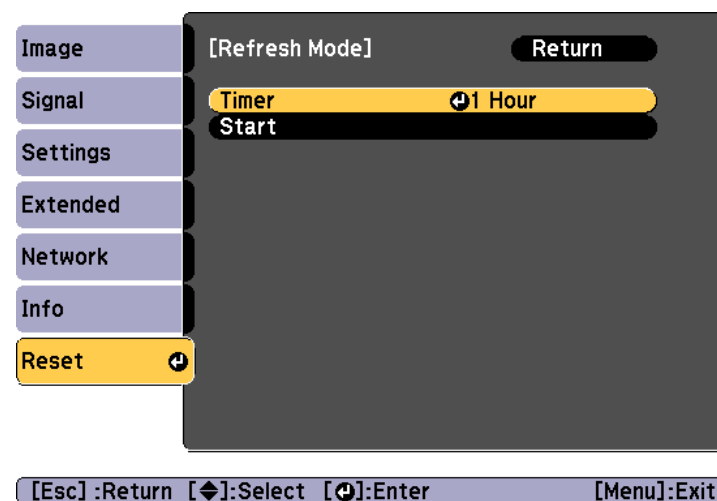

- 3 Select **Timer**, and then press the [**↵**] button.



- 4 Use the [**▲**][**▼**] buttons to set the time, and then press the [**↵**] button.

- 5 Select **Start**, and then press the [] button.
- 6 Select **Yes**, and then press the [] button.

Light Source Calibration

Execute Light Source Calibration to correct the white balance in the light source. We recommend running this function periodically.



- Whenever the usage time reaches 100 hours, Light Source Calibration starts automatically when the projector is turned off. However, this does not start automatically when the projector is used continuously for more than 24 hours, or when direct shutdown is used regularly. Execute with **Run Now**, or set **Light Source Calibration** using the scheduling function to adjust the light source periodically.
 - ☛ **Reset - Light Source Calibration** [p.113](#)
 - ☛ "Setting an Event Schedule" [p.71](#)
- If you do not want to start Light Source Calibration automatically, set **Run Periodically** to **Off**.
 - ☛ **Reset - Light Source Calibration - Run Periodically** [p.113](#)
- When **Light Source Calibration** is enabled, turn on the projector at least 20 minutes before the event.



Appendix

Epson Projector Management

Epson Projector Management lets you carry out operations such as checking the status of multiple Epson projectors that are connected to a network at a computer monitor, and controlling the projectors from the computer.

Download the Epson Projector Management software from the following website.

<http://www.epson.com>

Using the Mail Notification Function to Report Problems

When you set Mail Notification, notification messages are sent to the preset email addresses when a problem or warning occurs with a projector. This will enable the operator to be notified of problems with projectors even at locations away from the projectors.

☛ **Network - Notifications - Mail Notification** [p.109](#)



- Up to a maximum of three notification destinations (addresses) can be registered, and notification messages can be sent to all three destinations at once.
- If a projector develops a critical problem and suddenly stops working, it may not be able to send a message notifying an operator of the problem.
- If you set **Standby Mode** to **Communication On**, you can control the projector even if it is in standby mode (when the power is off).

☛ **Extended - Standby Mode** [p.99](#)

Reading error notification mail

When the Mail Notification function is set to On and a problem or warning occurs in the projector, the following email will be sent.

Sender: The email address set in **From**

Subject: EPSON Projector

Line 1: The projector name where the problem has occurred

Line 2: The IP address set for the projector where the problem has occurred.

Line 3 and on: Details of the problem

The details of the problem are listed line by line. The main message contents are listed below.

- Internal error
- Fan related error
- Sensor error
- Laser error (Laser Error/Laser Does Not Turn On)
- Laser warning
- Retardation Plate Error
- Internal temperature error
- High-speed cooling in progress
- No-signal
No Signal is input to the projector. Check the connection status or check that the power for the signal source is turned on.

See the following to deal with problems or warnings.

☛ "Reading the Indicators" [p.119](#)

Management Using SNMP

By setting **SNMP** to **On** in the Configuration menu, notification messages are sent to the specified computer when a problem or warning occurs. This allows you to check for problems with projectors even at locations away from the projectors.

☛ **Network - Notifications - SNMP** [p.109](#)



- SNMP should be managed by a network administrator or someone who is familiar with the network.
- To use the SNMP function to monitor the projector, you need to install the SNMP manager program on your computer.
- The SNMP Agent for this projector complies with version 1 (SNMPv1).
- The managing function using SNMP cannot be used over wireless LAN in Quick connection mode.
- Up to two destination IP addresses can be saved.

ESC/VP21 Commands

You can control the projector from an external device using ESC/VP21.

Command list

When the power ON command is transmitted to the projector, the power turns on and it enters warm-up mode. When the projector's power has turned on, a colon ":" (3Ah) is returned.

When a command is input, the projector executes the command and returns a ":", and then accepts the next command.

If the command being processed terminates abnormally, an error message is output and a ":" is returned.

The main contents are listed below.

Item		Command
Power ON/OFF	On	PWR ON
	Off	PWR OFF
Signal selection	HDMI	SOURCE 30
	LAN	SOURCE 53
	SD Player	SOURCE 57
	Spotlight	SOURCE 58
A/V Mute On/Off	On	MUTE ON
	Off	MUTE OFF

Add a Carriage Return (CR) code (0Dh) to the end of each command and transmit.

For more details, contact your local dealer or the nearest address provided in the Epson Projector Contact List.

☛ [Epson Projector Contact List](#)

About PJLink

PJLink was established by the JBMIA (Japan Business Machine and Information System Industries Association) as a standard protocol for controlling network-compatible projector's as part of their efforts to standardize projector control protocols.

The projector complies with the PJLink Class2 standard established by the JBMIA.

The port number used by the PJLink search function is 4352 (UDP).

You need to make network settings before you can use PJLink. See the following for more information on network settings.

☛ "Network Menu" [p.102](#)

It complies with all commands except for the following commands defined by PJLink Class2, and agreement was confirmed by the PJLink standard adaptability verification.

URL: <http://pjlink.jbmia.or.jp/english/>

- **Non-compatible commands**

	Function	PJLink Command
Mute settings	Image muting set	AVMT 11
	Audio muting set	AVMT 21

- **Enter the port name and the input source number**

Input Port Name	Input Source Number
HDMI	32
SD Player	43
Spotlight	44
LAN	52

- Manufacturer name displayed for "Manufacture name information query"
EPSON
- Model name displayed for "Product name information query"
EPSON EV105/EV100

About Crestron Connected®

Crestron Connected® is an integrated control system provided by Crestron®. It can be used to monitor and control multiple devices connected on a network.

The projector supports the control protocol, and can therefore be used in a system built with Crestron Connected®.

Visit the Crestron® Web site for details on Crestron Connected®. (Only English-language displays are supported.)

<https://www.crestron.com/products/line/crestron-connected>

The following provides an overview of Crestron Connected®.

- **Remote operation using a Web browser**

You can operate a projector from your computer just like using a remote control.

- **Monitoring and control with application software**

You can use Crestron RoomView® Express/Crestron Fusion® provided by Crestron® to monitor devices in the system, to communicate with the help desk, and to send emergency messages.

This manual describes how to perform operations on your computer using a Web browser.



- You can only enter single-byte alphanumeric characters and symbols.
- The following functions cannot be used while using Crestron Connected®.
The Message Broadcasting feature in the Epson Projector Management software
- If you set **Standby Mode** to **Communication On**, you can control the projector even if it is in standby mode (when the power is off).
☞ **Extended - Standby Mode p.99**

Operating a projector from your computer

Displaying the operation window

Check the following before carrying out any operations.

- Make sure the computer and projector are connected to the network.

- Set **Crestron Connected** from the **Network** menu to **On**.
 ⏪ **Network - Others - Crestron Connected** p.110

- 1 Start the Web browser on the computer.
- 2 Enter the IP address of the projector in the address field of the Web browser, and press the Enter key on the keyboard.
 The Epson Web Control home screen is displayed.

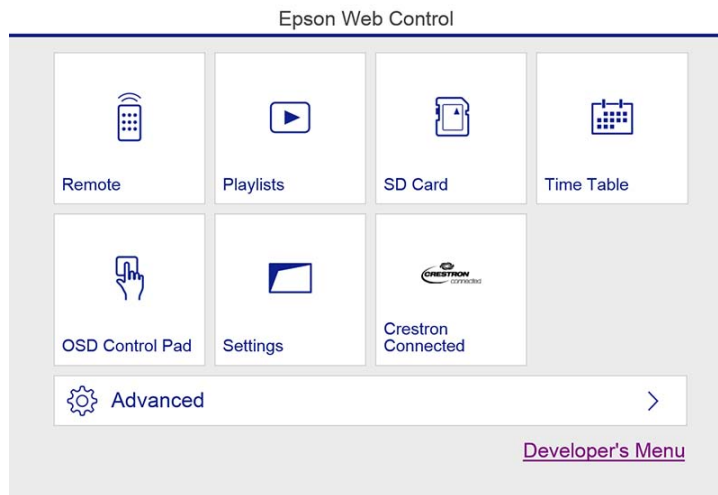

- 3 Press **Crestron Connected**.
 The operation window is displayed.

Using the operation window

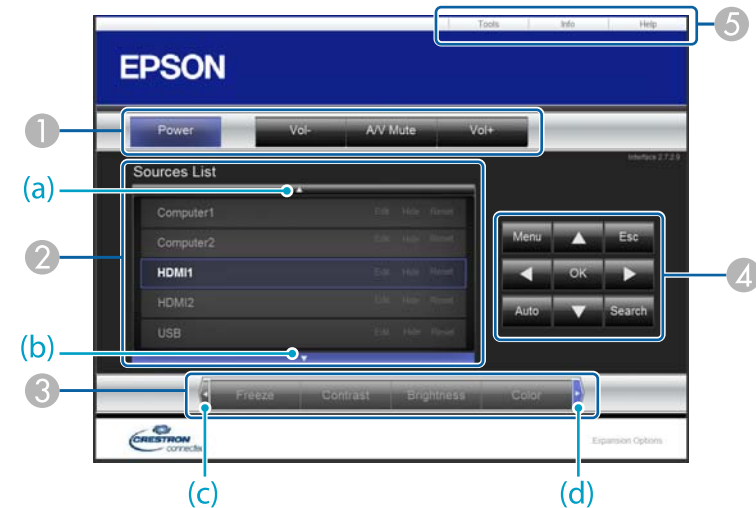

- 1 You can perform the following operations when you click the buttons.

Button	Function
Power	Turns the projector power on or off.
Vol-/Vol+	Adjusts the volume.
A/V Mute	Turns the video and audio on or off. ⏪ "Hiding the Image and Sound Temporarily (A/V Mute)" p.58

- 2 Switch to the image from the selected input source. To display input sources that are not shown in Source List, click (a) or (b) to scroll up or down. The current video signal input source is displayed in blue.
 You can change the source name if necessary.
- 3 You can perform the following operations when you click the buttons. To display buttons that are not shown in Source List, click (c) or (d) to scroll left or right.

Button	Function
Contrast	Adjusts the difference between light and shade in the images.
Brightness	Adjusts the image brightness.
Color	Adjusts the color saturation for the images.
Sharpness	Adjusts the image sharpness.
Zoom	Click the [⊕] button to enlarge the size of the projection. Click the [⊖] button to reduce the size of the projection. Click the [▲] [▼] [◀] [▶] buttons to change the position of an enlarged image.

- 4 The [▲] [▼] [◀] [▶] buttons perform the same operations as the [▲] [▼] [◀] [▶] buttons on the remote control. You can perform the following operations when you click the other buttons.

Button	Function
OK	Performs the same operation as the [↵] button on the remote control. 🖱️ "Remote Control" p.18
Menu	Displays and closes the Configuration menu.
Esc	Performs the same operation as the [Esc] button on the remote control. 🖱️ "Remote Control" p.18

- 5 You can perform the following operations when you click the tabs.

Tab	Function
Help	Displays the Help Desk window. Used to send messages to, and receive messages from, the administrator using Crestron Connected®.

Tab	Function
Info	Displays information on the projector that is currently connected.
Tools	Changes settings in the projector that is currently connected. See the next section.

Using the tools window

The following window is displayed when you click the **Tools** tab on the operation window. You can use this window to change settings in the projector that is currently connected.

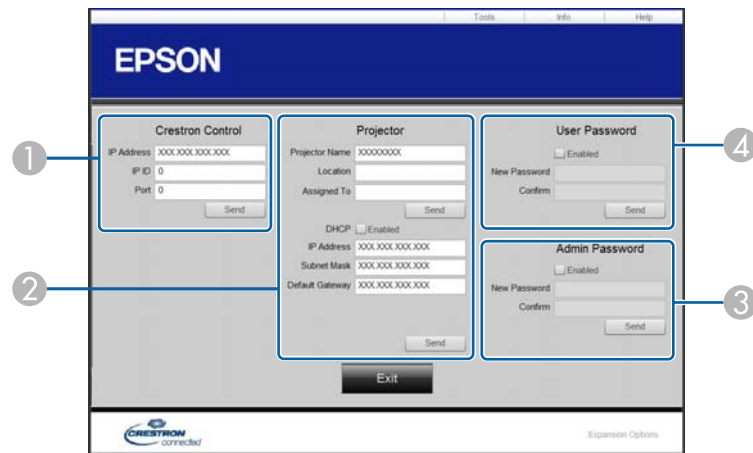

- 1 **Crestron Control**
Make settings for Crestron® central controllers.
- 2 **Projector**
The following items can be set.

Item	Function
Projector Name	Enter a name to differentiate the projector that is currently connected from other projectors on the network. (The name can contain up to 15 single-byte alphanumeric characters.)
Location	Enter an installation location name for the projector that is currently connected on the network. (The name can contain up to 32 single-byte alphanumeric characters and symbols.)
Assigned To	Enter a user name for the projector. (The name can contain up to 32 single-byte alphanumeric characters and symbols.)

Item	Function
DHCP	Select the Enabled check box to use DHCP. You cannot enter an IP address if DHCP is enabled.
IP Address	Enter the IP address to assign to the currently connected projector.
Subnet Mask	Enter a subnet mask for the currently connected projector.
Default Gateway	Enter the gateway address for the currently connected projector.
Send	Click this button to confirm the changes made to the Projector .

- 3 **Admin Password**
Select the **Enabled** check box to require a password to open the Tools window. The following items can be set.

Item	Function
New Password	Enter the new password when changing the password to open the Tools window. (The name can contain up to 26 single-byte alphanumeric characters.)
Confirm	Enter the same password as you entered in New Password . If the passwords are not the same, an error is displayed.
Send	Click this button to confirm the changes made to the Admin Password .

- 4 **User Password**
Select the **Enabled** check box to require a password to open the operation window on the computer. The following items can be set.

Item	Function
New Password	Enter the new password when changing the password to open the operation window. (The name can contain up to 26 single-byte alphanumeric characters.)
Confirm	Enter the same password as you entered in New Password . If the passwords are not the same, an error is displayed.
Send	Click this button to confirm the changes made to the User Password .

Art-Net

Art-Net is an Ethernet communication protocol based on the TCP/IP protocol.

You can control the projector by using a DMX controller or an application system.

Channel definitions

The following explains the channel definitions used when controlling the projector in Art-Net.

Channel	Function	Operation		Parameters	Default	Operation Content
1	Adjusting light (Dimming)	0% - 100%		0 - 255	0	Sets the image brightness.
2	Shutter control	Shutter	Open	0 - 63	128	Enables/disables A/V Mute.
		Non-operational		64 - 191		
		Shutter	Closed	192 - 255		
3	Switch source	Non-operational		0 - 7	0	Changes to the specified source.
		HDMI		8 - 15		
		LAN		16 - 23		
		SD Player		24 - 31		
		Spotlight		32 - 39		
		Non-operational		40 - 255		
7	Zoom	(+) lens adjustment	Movement - Large	0 - 31	128	Zooms using the amount of movement specified.
			Movement - Medium	32 - 63		
			Movement - Small	64 - 95		
		Non-operational		96 - 159		
		(-) lens adjustment	Movement - Small	160 - 191		
			Movement - Medium	192 - 223		



Channel	Function	Operation		Parameters	Default	Operation Content
			Movement - Large	224 - 255		
8	Electronic focus	(+) lens adjustment	Movement - Large	0 - 31	128	Performs electronic focus using the amount of movement specified.
			Movement - Medium	32 - 63		
			Movement - Small	64 - 95		
		Non-operational		96 - 159		
		(-) lens adjustment	Movement - Small	160 - 191		
			Movement - Medium	192 - 223		
			Movement - Large	224 - 255		
10	Content Playback	Non-operational		0 - 3	0	Plays the specified playlist.
		Playlist1		4 - 7		
		Playlist2		8 - 11		
		Playlist3		12 - 15		
		Playlist4		16 - 19		
		Playlist5		20 - 23		
		Playlist6		24 - 27		
		Playlist7		28 - 31		
		Playlist8		32 - 35		
		Playlist9		36 - 39		
		Playlist10		40 - 43		
		Playlist11		44 - 47		
		Playlist12		48 - 51		
		Playlist13		52 - 55		
		Playlist14		56 - 59		



Channel	Function	Operation	Parameters	Default	Operation Content
		Playlist15	60 - 63		
10	Content Playback	Playlist16	64 - 67	0	Plays the specified playlist.
		Playlist17	68 - 71		
		Playlist18	72 - 75		
		Playlist19	76 - 79		
		Playlist20	80 - 83		
		Playlist21	84 - 87		
		Playlist22	88 - 91		
		Playlist23	92 - 95		
		Playlist24	96 - 99		
		Playlist25	100 - 103		
		Playlist26	104 - 107		
		Playlist27	108 - 111		
		Playlist28	112 - 115		
		Playlist29	116 - 119		
		Playlist30	120 - 123		
		Playlist31	124 - 127		
		Playlist32	128 - 131		
		Playlist33	132 - 135		
		Playlist34	136 - 139		
		Playlist35	140 - 143		
Playlist36	144 - 147				
Playlist37	148 - 151				
Playlist38	152 - 155				
Playlist39	156 - 159				

Channel	Function	Operation	Parameters	Default	Operation Content
10	Content Playback	Playlist40	160 - 163	0	Plays the specified playlist.
		Playlist41	164 - 167		
		Playlist42	168 - 171		
		Playlist43	172 - 175		
		Playlist44	176 - 179		
		Playlist45	180 - 183		
		Playlist46	184 - 187		
		Playlist47	188 - 191		
		Playlist48	192 - 195		
		Playlist49	196 - 199		
		Playlist50	200 - 203		
		Non-operational	204 - 255		
11	Power control	Power off	0 - 63	128	Turns the projector power on or off.
		Non-operational	64 - 191		
		Power on	192 - 255		
13	Lock	Cannot control	0 - 127	0	Enables/disables Art-Net operations.
		Can control	128 - 255		



While controlling the projector using Art-Net and performing operations from the remote control, settings made by the DMX controller or application software may differ from the actual projector's status. When you want to apply all the channel controls to the projector, set Channel 13 to "Cannot control", then set it back to "Can control".

Web API

You can operate the projector using Web API.

You can enable Web API from a Web browser.

- 1** Open the Epson Web Control home screen from your Web browser.
- 2** Press the **Developer's Menu** button.
- 3** Set **Enable API** to **On**.
 - ☛ "Operating Using Epson Web Control (Web Browser)" [p.40](#)

The projector supports the following Web APIs.

URL	Supported methods	Explanation
http://<ip address>/api/v01/contentmgr/remote/power/on	GET/POST/PUT	Turns the projector on. (It takes a while for the WebAPI to respond.)
http://<ip address>/api/v01/contentmgr/remote/power/off	GET/POST/PUT	Turns the projector off.
http://<ip address>/api/v01/contentmgr/playlist/play/:id	GET/POST/PUT	Plays the specified ID playlist. Enter the ID for the playlist in :id. You can check the playlist ID from the Developer's Menu on the home screen.
http://<ip address>/api/v01/contentmgr/playlist/stop	GET/POST/PUT	Stops the playlist currently being played.

Enter the IP address for the projector in <ip address>.

For example, a URL instructing a projector with the IP address 192.168.0.2 to playback playlist ID 3 would look like this:

http://192.168.0.2/api/v01/contentmgr/playlist/play/3

If secure HTTP is enabled, change the http in the URL to https.

The following optional accessories are available. Please purchase these products as and when needed. The following list of optional accessories and consumables is current as of: April 2018. Details of accessories are subject to change without notice and availability may vary depending on the country of purchase.

Lighting Track Mount(White) ELPMB54W**Lighting Track Mount(Black) ELPMB54B**

Use when installing the projector on a lighting track.

Floor Stand(White) ELPMB55W**Floor Stand(Black) ELPMB55B**

Use when installing the projector on the floor.

- * Special expertise is required to suspend the projector from a ceiling or mount it on a wall. Make sure you contact a professional.

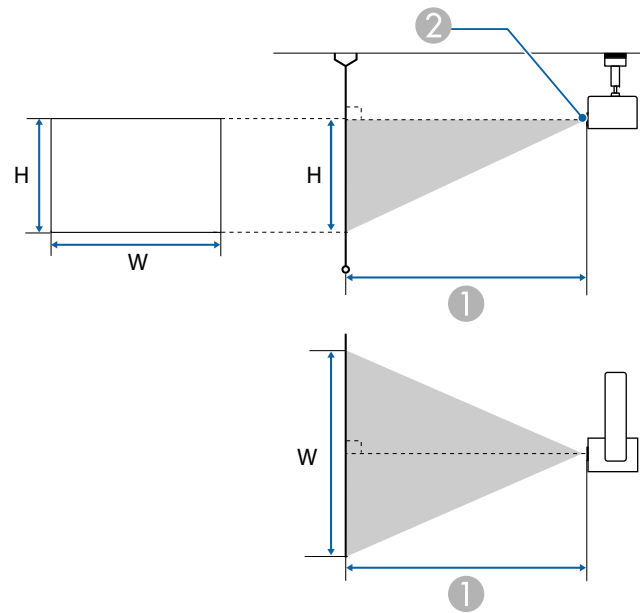

- ① Projection distance
- ② Center of lens

Unit: cm

16:10 Screen Size		①
		Minimum (Wide) to maximum (Tele)
29"	63x39	85 to 136
30"	64x40	88 to 141
40"	86x54	118 to 189
50"	108x67	149 to 237
60"	129x81	179 to 285
80"	172x108	239 to 381
100"	215x135	300 to 476
120"	258x162	360 to 572

16:10 Screen Size		①
		Minimum (Wide) to maximum (Tele)
133"	286x179	400 to 634
150"	323x202	451 to 716

Unit: cm

4:3 Screen Size		①
		Minimum (Wide) to maximum (Tele)
25"	51x38	83
30"	61x46	100 to 160
40"	81x61	134 to 214
50"	102x76	169 to 268
60"	122x91	203 to 323
80"	163x122	271 to 431
100"	203x152	340 to 540
120"	244x183	408 to 648
133"	270x203	453 to 719
150"	305x229	511 to 811
200"	406x305	682 to 1082

Unit: cm

16:9 Screen Size		①
		Minimum (Wide) to maximum (Tele)
28"	62x35	84
30"	66x37	91 to 145
40"	89x50	122 to 194
50"	111x62	153 to 243
60"	133x75	184 to 293



16:9 Screen Size		①
		Minimum (Wide) to maximum (Tele)
80"	177x100	246 to 391
100"	221x125	308 to 490
133"	294x166	411 to 652
150"	332x187	464 to 736
200"	443x249	619 to 982
250"	553x311	775 to 1228

* When the aspect ratio is 16:9, the top edge of the projected image shifts from the lens center.

When the resolution of the input signals is larger than the projector's panel resolution, the image quality may decline.

Signals with a check mark are supported.

Signal type	Signal format	Resolution (Dot)		V Sync (Hz)	HDMI			
					RGB (8bit)	YCbCr (8bit)		
						4:4:4	4:2:2	4:2:0
PC	VGA	640	480	60	✓			
				72				
				75				
				85				
	SVGA	800	600	60	✓			
				72				
				75				
				85				
	XGA	1024	768	60	✓			
				70				
				75				
				85				
	WXGA	1280	768	60				
				60	✓			
		1280	800	75				
				85				
	1366	768	60	✓				
	WXGA+	1440	900	60	✓			
				75				
85								
WXGA++	1600	900	60	✓				
SXGA	1280	960	60	✓				



Signal type	Signal format	Resolution (Dot)		V Sync (Hz)	HDMI					
					RGB (8bit)	YCbCr (8bit)				
						4:4:4	4:2:2	4:2:0		
				75						
				85						
				1280	1024	60	✓			
				75						
				85						
	SXGA+	1400	1050	60	✓					
				75						
	WSXGA+	1680	1050	60	✓					
	UXGA	1600	1200	60	✓					
	1920x1080	1920	1080	50						
				60						
WUXGA RB*	1920	1200	60	✓						
SD	SDTV (480i)	720	480	60	✓	✓	✓			
	SDTV (576i)	720	576	50	✓	✓	✓			
	SDTV (480p)	720	480	60	✓	✓	✓			
	SDTV (576p)	720	576	50	✓	✓	✓			
HD	HDTV (720p)	1280	720	50	✓	✓	✓			
				60	✓	✓	✓			
	HDTV (1080i)	1920	1080	50	✓	✓	✓			
				60	✓	✓	✓			
	HDTV (1080p)	1920	1080	24	✓	✓	✓			
				30	✓	✓	✓			
50				✓	✓	✓				

Signal type	Signal format	Resolution (Dot)		V Sync (Hz)	HDMI		
					RGB (8bit)	YCbCr (8bit)	
						4:4:4	4:2:2
				60	✓	✓	✓

* Based on VESA CVT-RB (Reduced Blanking)

Projector General Specifications

Product name		EV-100 (White) EV-105 (Black)
Dimensions		Image projection unit: Diameter 175 x Depth 260 mm Power unit: Width 361 x Depth 110 x Height 65 mm (without power adapter cover) Power unit: Width 459 x Depth 110 x Height 65 mm (with power adapter cover)
LCD panel size		0.59" Wide
Display method		Polysilicon TFT active matrix
Resolution		1,024,000 WXGA (1280 (horizontal) x 800 (vertical) dots) x3
Focus adjustment		Automatic
Zoom adjustment		Automatic (1-2.21) (Optical 1-1.58, Digital 1-1.4)
Light source		Laser diode
Light source output power		Up to 88 W
Wavelength		440 to 460 nm
Light source life expectancy		Approximately 20,000 hours (Light Source Mode: Normal, Quiet) Approximately 30,000 hours (Light Source Mode: Extended)
Power supply		100-240 V AC±10% 50/60 Hz 1.8 to 0.8 A
Power consumption	100 to 120 V area	Rated power consumption: 173 W Standby power consumption (Communication On): 2.0 W Standby power consumption (Communication Off): 0.3 W
	220 to 240 V area	Rated power consumption: 170 W Standby power consumption (Communication On): 2.0 W Standby power consumption (Communication Off): 0.3 W
Operating altitude		Altitude 0 to 3,048 m
Operating temperature		+5 to +40°C* (No condensation)
Storage temperature		-10 to +60°C (No condensation)

Mass	Approx. 6.9 kg (main projector section approx. 5.0 kg/Direct Mount approx. 1.9 kg)
-------------	--

* If the surrounding temperature gets too high, the brightness is automatically dimmed.
 (Approximately 40°C at an altitude of 0 to 1,500 m, and approximately 35°C at an altitude of 1,501 to 3,048 m; however, this may vary depending on the surroundings and so on.)

Connec- tors	HDMI port	1	HDMI HDCP supported (Audio is only supported by PCM)
	Audio Out port	1	Stereo mini jack (3.5Φ)
	LAN port	1	RJ-45
	USB port (dedicated power supply)	1	USB connector (Type A)
	SD card slot	1	SDHC/microSDHC, Class10 or higher, Maximum of 32 GB, FAT16/FAT32 supported

This product is also designed for IT power distribution system with phase-to-phase voltage 230V.

Supplier's DECLARATION of CONFORMITY

According to 47CFR, Part 2 and 15

Class B Personal Computers and Peripherals; and/or
CPU Boards and Power Supplies used with Class B Personal Computers

We: Epson America, Inc.
Located at: 3840 Kilroy Airport Way
MS: 3-13
Long Beach, CA 90806
Tel: 562-981-3840

Declare under sole responsibility that the product identified herein, complies with 47CFR Part 2 and 15 of the FCC rules as a Class B digital device. Each product marketed, is identical to the representative unit tested and found to be compliant with the standards. Records maintained continue to reflect the equipment being produced can be expected to be within the variation accepted, due to quantity production and testing on a statistical basis as required by 47CFR 2.909.

Trade Name: EPSON
Type of Product: LCD Projector
Model: H868C

**FCC Compliance Statement
For United States Users**

This equipment has been tested and found to comply with the limits for a Class B digital device, pursuant to Part 15 of the FCC Rules. These limits are designed to provide reasonable protection against harmful interference in a residential installation. This equipment generates, uses, and can radiate radio frequency energy and, if not installed and used in accordance with the instructions, may cause harmful interference to radio communications. However, there is no guarantee that interference will not occur in a particular installation. If this equipment does cause interference to radio or television reception, which can be determined by turning the equipment off and on, the user is encouraged to try to correct the interference by one or more of the following measures.

- Reorient or relocate the receiving antenna.
- Increase the separation between the equipment and receiver.
- Connect the equipment into an outlet on a circuit different from that to which the receiver is connected.
- Consult the dealer or an experienced radio/TV technician for help.
- Operation is subject to the following two conditions : (1) this device may not cause harmful interference, and (2) this device must accept any interference received, including interference that may cause undesired operation.

WARNING

The connection of a non-shielded equipment interface cable to this equipment will invalidate the FCC Certification or Declaration of this device and may cause interference levels which exceed the limits established by the FCC for this equipment. It is the responsibility of the user to obtain and use a shielded equipment interface cable with this device. If this equipment has more than one interface connector, do not leave cables connected to unused interfaces. Changes or modifications not expressly approved by the manufacturer could void the user's authority to operate the equipment.

Units: mm

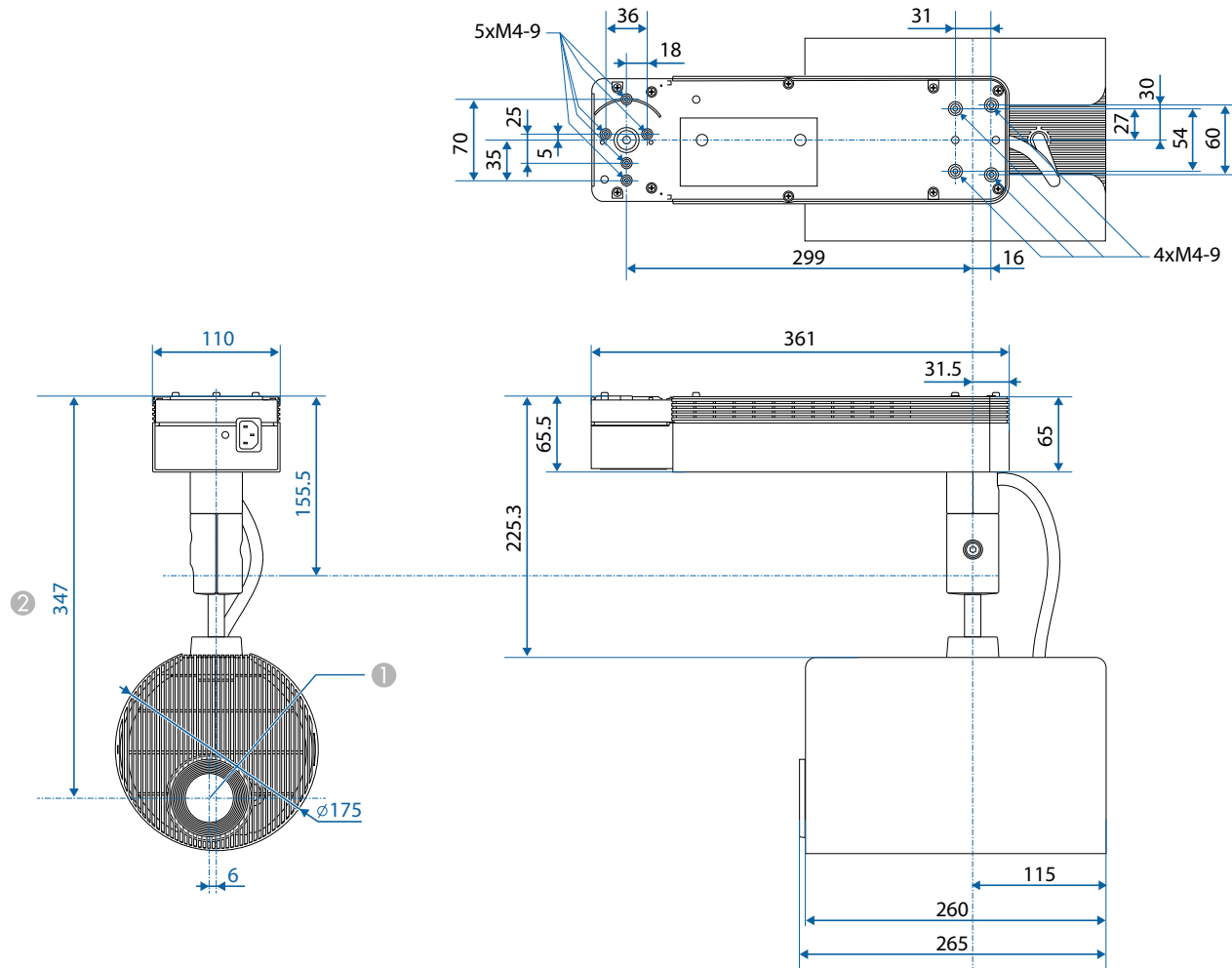

- ① Center of lens
- ② Distance from center of lens to mount fixing points

This section briefly explains the difficult terms that are not explained in the text of this guide. For details, refer to other commercially available publications.

Aspect Ratio	The ratio between an image's length and its height. Screens with a horizontal:vertical ratio of 16:9, such as HDTV screens, are known as wide screens. SDTV and general computer displays have an aspect ratio of 4:3.
Contrast	The relative brightness of the light and dark areas of an image can be increased or decreased to make text and graphics stand out more clearly, or to make them appear softer. Adjusting this particular property of an image is called contrast adjustment.
DHCP	An abbreviation of Dynamic Host Configuration Protocol, this protocol automatically assigns an IP Address to equipment connected to a network.
Gateway Address	This is a server (router) for communicating across a network (subnet) divided according to Subnet Mask .
HDCP	HDCP is an abbreviation for High-bandwidth Digital Content Protection. It is used to prevent illegal copying and protect copyrights by encrypting digital signals sent over DVI and HDMI ports. HDCP2.2 is a copyright protection standard for 4K content.
HDTV	An abbreviation for High-Definition Television that refers to high-definition systems which satisfy the following conditions. <ul style="list-style-type: none"> • Vertical resolution of 720p or 1080i or greater (p = Progressive, i = Interlace) • Screen Aspect Ratio of 16:9
Infrastructure mode	A method for wireless LAN connection in which devices communicate through access points.
Interlace	Transmits information needed to create one screen by sending every other line, starting from the top of the image and working down to the bottom. Images are more likely to flicker because one frame is displayed every other line.
IP Address	A number to identify a computer connected to a network.
Progressive	Projects information to create one screen at a time, displaying the image for one frame. Even though the number of scan lines is the same, the amount of flicker in images decreases because the volume of information has doubled compared with an interlace system.
Refresh Rate	The light-emitting element of a display maintains the same luminosity and color for an extremely short time. Because of this, the image must be scanned many times per second to refresh the light-emitting element. The number of refresh operations per second is called the Refresh rate and is expressed in hertz (Hz).
SDTV	An abbreviation for Standard Definition Television that refers to standard television systems which do not satisfy the conditions for HDTV High-Definition Television.
SNMP	An abbreviation for Simple Network Management Protocol, which is the protocol for monitoring and controlling devices such as routers and computers connected to a TCP/IP network.
Subnet Mask	This is a numerical value that defines the number of bits used for the network address on a divided network (subnet) from the IP address.
Sync.	The signals output from computers have a specific frequency. If the projector frequency does not match this frequency, the resulting images are not of a good quality. The process of matching the phases of these signals (the relative position of the crests and the troughs in the signal) is called Synchronization. If the signals are not synchronized, flickering, blurriness, and horizontal interference occur.
Trap IP Address	This is the IP Address for the destination computer used for error notification in SNMP.

All rights reserved. No part of this publication may be reproduced, stored in a retrieval system, or transmitted in any form or by any means, electronic, mechanical, photocopying, recording, or otherwise, without the prior written permission of Seiko Epson Corporation. No patent liability is assumed with respect to the use of the information contained herein. Neither is any liability assumed for damages resulting from the use of the information contained herein.

Neither Seiko Epson Corporation nor its affiliates shall be liable to the purchaser of this product or third parties for damages, losses, costs, or expenses incurred by the purchaser or third parties as a result of: accident, misuse, or abuse of this product or unauthorized modifications, repairs, or alterations to this product, or (excluding the U.S.) failure to strictly comply with Seiko Epson Corporation's operating and maintenance instructions.

Seiko Epson Corporation shall not be liable against any damages or problems arising from the use of any options or any consumable products other than those designated as Original Epson Products or Epson Approved Products by Seiko Epson Corporation.

The contents of this guide may be changed or updated without further notice.

Illustrations in this guide and the actual projector may differ.

Restriction of Use

When this product is used for applications requiring high reliability/safety such as transportation devices related to aviation, rail, marine, automotive etc.; disaster prevention devices; various safety devices etc; or functional/precision devices etc, you should use this product only after giving consideration to including fail-safes and redundancies into your design to maintain safety and total system reliability. Because this product was not intended for use in applications requiring extremely high reliability/safety such as aerospace equipment, main communication equipment, nuclear power control equipment, or medical equipment related to direct medical care etc, please make your own judgment on this product's suitability after a full evaluation.

Trademarks and Copyrights

"EPSON" is a registered trademark of Seiko Epson Corporation. "EXCEED YOUR VISION" are trademarks or registered trademarks of Seiko Epson Corporation.

Mac, Mac OS, OS X, and iOS are trademarks of Apple Inc.

Microsoft, Windows, Windows Server, Microsoft Edge, Windows Media, and the Windows logo are trademarks or registered trademarks of Microsoft Corporation in the United States and/or other countries.

App Store is a service mark of Apple Inc.

Android, Chrome, Chromebook, and Google Play are trademarks of Google Inc.

HDMI and High-Definition Multimedia Interface are the trademarks or registered trademarks of HDMI Licensing LLC. 

 SDHC Logo is a trademark of SD-3C, LLC.

PJLink trademark is a trademark applied for registration or is already registered in Japan, the United States of America and other countries and areas.

WPA™ and WPA2™ are registered trademarks of the Wi-Fi Alliance.

"QR Code" is a registered trademark of DENSO WAVE INCORPORATED.

Crestron, Crestron Connected, Crestron RoomView, and Crestron Fusion are registered trademarks of Crestron Electronics, Inc.

Art-Net™ Designed by and Copyright Artistic Licence Holdings Ltd.

Extron® and XTP® are registered trademarks of Extron Electronics.

This product includes RSA BSAFETM software from RSA Security Inc. RSA is a registered trademark of RSA Security Inc. BSAFE is a registered trademark of RSA Security Inc. in the United States and/or other countries.

Other product names used herein are also for identification purposes only and may be trademarks of their respective owners. Epson disclaims any and all rights in those marks.

©SEIKO EPSON CORPORATION 2018. All rights reserved.

Indication of the manufacturer and the importer in accordance with requirements of EU directive

Manufacturer: SEIKO EPSON CORPORATION

Address: 3-5, Owa 3-chome, Suwa-shi, Nagano-ken 392-8502 Japan

Telephone: 81-266-52-3131

<http://www.epson.com/>







Importer: EPSON EUROPE B.V.







Address: Atlas Arena, Asia Building, Hoogoorddreef 5, 1101 BA Amsterdam
Zuidoost The Netherlands

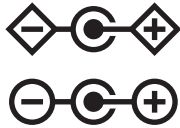

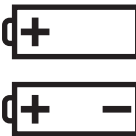





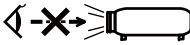

Telephone: 31-20-314-5000

<http://www.epson.eu/>

The following table lists the meaning of the safety symbols labeled on the equipment.

No.	Symbol mark	Approved standards	Meaning
①		IEC60417 No. 5007	"ON" (power) To indicate connection to the mains.
②		IEC60417 No. 5008	"OFF" (power) To indicate disconnection from the mains.
③		IEC60417 No. 5009	Stand-by To identify the switch or switch position by means of which part of the equipment is switched on in order to bring it into the stand-by condition.
④		ISO7000 No. 0434B IEC3864-B3.1	Caution To identify general caution when using the product.
⑤		IEC60417 No. 5041	Caution, hot surface To indicate that the marked item can be hot and should not be touched without taking care.
⑥		IEC60417 No. 6042 ISO3864-B3.6	Caution, risk of electric shock To identify equipment that has risk of electric shock.
⑦		IEC60417 No. 5957	For indoor use only To identify electrical equipment designed primarily for indoor use.
⑧		IEC60417 No. 5926	Polarity of d.c. power connector To identify the positive and negative connections (the polarity) on a piece of equipment to which a d.c. power supply may be connected.

No.	Symbol mark	Approved standards	Meaning
⑨		IEC60417 No. 5001B	Battery, general On battery powered equipment. To identify a device for instance a cover for the battery compartment, or the connector terminals.
⑩		IEC60417 No. 5002	Positioning of cell To identify the battery holder itself and to identify the positioning of the cell(s) inside the battery holder.
⑪		IEC60417 No. 5019	Protective earth To identify any terminal which is intended for connection to an external conductor for protection against electric shock in case of a fault, or the terminal of a protective earth electrode.
⑫		IEC60417 No. 5017	Earth To identify an earth (ground) terminal in cases where symbol No. 11 is not explicitly required.
⑬		IEC60417 No. 5032	Alternating current To indicate on the rating plate that the equipment is suitable for alternating current only; to identify relevant terminals.
⑭		IEC60417 No. 5031	Direct current To indicate on the rating plate that the equipment is suitable for direct current only; to identify relevant terminals.
⑮		IEC60417 No. 5172	Class II equipment To identify equipment meeting the safety requirements specified for Class II equipment according to IEC 61140.

No.	Symbol mark	Approved standards	Meaning
16		ISO 3864	General prohibition To identify actions or operations that are prohibited.
17		ISO 3864	Contact prohibition To indicate injury that could occur due to touching a specific part of the equipment.
18		---	Never look into the projection lens while the projector is on.
19		---	To indicate that you should not place anything on the projector.
20		ISO 3864 IEC60825-1	Caution, laser radiation To indicate the equipment has a laser radiation part.
21		ISO 3864	Disassembly prohibition To indicate a risk of injury, such as electric shock, if the equipment is disassembled.
22		IEC60417 No. 5266	Standby, partial standby To indicate that part of the equipment is in the ready status.
23		ISO 3864 IEC60417 No. 5057	Caution, movable parts To indicate that you must keep away from movable parts according to protection standards.
24		IEC 60417-6056	Caution (Moving Fan Blades) As a safety precaution, stay away from the moving fan blades.
25		IEC 60417-6043	Caution (Sharp Corners) To indicate sharp corners that should not be touched.
26		---	To indicate that looking into the lens while projecting is prohibited.

A

A/V Mute	58
Air exhaust vent	15
Air intake vent	14
Art-Net	111, 149
Aspect	54, 97
Audio Out port	16
Auto Power On	100

B

Ball joint	14
Basic menu	104
Batch setup function	114
Brightness	47, 96
Brightness Settings	52

C

Cleaning	138
Cleaning the projector's surface	138
Color Adjustment	55
Color adjustment	97
Color Filter	46
Color Matching	67, 101
Color Mode	52, 96, 101
Color Saturation	96
Color Uniformity	65, 99, 101
Configuration menu	92
Content Playback	99
Contrast	96
Crestron Connected	110, 144

D

Date & Time	30, 100
DHCP	106, 108
Direct Mount fixing points	17
Direct Power On	100
Display	99
Distance	155
Dynamic Contrast	54, 97

E

Edge Blending	62, 101
Epson iProjection	40
Epson Projector Management	142
Epson Web Control	40
ESC/VP21	143
Event ID	112
Extended menu	99

F

Floor Stand fixing points	17
Focus	49
Front	100

G

Gateway Address	106, 108
-----------------------	----------

H

H/V-Keystone	50, 98
HDMI port	16
High Altitude Mode	100

I

Image Menu	96
Indicators	15, 119
Info menu	112
Input Signal	112
IP Address	106, 108

K

Keystone	49, 98
----------------	--------

L

LAN port	16
Language	101
Light Source Calibration	6, 113, 140
Lighting Track Mount fixing points	17

M

Mail Notification	109, 142
Message Broadcasting	111
Messages	99
Moderator Password	104
Monitor displays	157
Multi-Projection	60, 101

N

Network Configuration	103
Network information	102
Network menu	102
Notification email address 1/2/3	110
Notifications menu	109

O

Operating Temperature	160
Operation	100
Others	110
Overheating	121
Overlay Effect	45

P

Part names and functions	14
Password Protection	73
PJLink	143
PJLink Password	104
Playlist	38
Port Number	109
Power adapter cover	16
Power inlet	16
Priority Gateway	110
Projection	100
Projector	34, 35
Projector ID	61
Projector keyword	104
Projector Name	104

Q

QR code	86
Quick Corner	51, 98

R

Reading mail	142
Rear	100
Refresh Mode	113, 139
Refresh Rate	112

Remote control	18
Remote receiver	15
Replacing batteries	26
Reset All	113
Reset menu	113
Resolution	112

S

Scale	97, 101
Schedule	71
Schedule Settings	101
Screen size	155
SD card	38
SD card slot	16
Search Access Point	107
Secure HTTP	88, 110
Serial Number	112
Settings menu	98
Shape Filter	45
Sharpness	96
Signal menu	97
SMTP Server	109
SNMP	143
Soft keyboard	103
Source	112
Specifications	160
Spotlight	37
Standby Mode	100
Startup Screen	99
Status	112
Storage temperature	160
Subnet Mask	106, 108
Supported monitor displays	157

Sync Info	112
Synchronized playback	69

T

Test Pattern	48, 98
Tint	96
Trap IP Address 1/2	110

U

USB-A port	16
User Button	98
User's Logo	70

V

Volume	57, 98
--------------	--------

W

WEB API	153
Web Control Password	104
Web Server Cert.	110
Web Server Certificate	88
White Balance	97
Wired LAN menu	108
Wireless LAN menu	105

Z

Zoom	49
------------	----